

## **Historic, Archive Document**

Do not assume content reflects current scientific knowledge, policies, or practices.



62,39  
1910

# HOWARD & MORROW

59 North Street, :::: Pittsfield, Massachusetts



STECHER CO. ROCHESTER, N.Y.

**Seeds** *Agricultural Implements, Poultry  
and Dairy Supplies* 🌿 *Fertilizers,  
Lime* 🌿 *Cement* 🌿 *Sewer Pipe* 🌿 *Flue Lining*  
*Contractors' Tools*

# ... PAINT ...



“LOWE BROTHERS ‘High Standard’ PAINTS.” These Paints are BEAUTIFUL GOODS. They have COVERING POWER, SPREADING CAPACITY, DURABILITY and are SPLENDID COLORS and FULL MEASURE. Watch for the LITTLE BLUE FLAG on the can, it insures good paint and satisfaction. Get our Color Cards.



LOWE BROTHERS’ VARNISHES—Excellent goods in six kinds. “Elastic General Purpose,” “Quick Action House,” “Interior House,” “Durable Floor,” “Spar Varnish,” and “Crystal Finish,” all packages carry the little blue flag denoting quality.

# JAP-A-LAC

Registered  
“WEARS LIKE IRON”

You have heard of

JAP-A-LAC

We Sell It

## Cyphers’ Incubators and Brooders

At Factory Prices.

We Save You Money on These Goods.

We are the Sole Agents in this vicinity for the Cyphers Incubators, Brooders, and Poultry Goods.

Our stock of Poultry Supplies is very large and of the Best Quality. See pages 72-77.





---

---

QUANTITY

ARTICLES

PRICES

---

---







—OF—

# Reliable “Seeds That Grow”

## TOOLS AND MACHINERY

---

“Our Seeds are Northern Grown, None Better at Any Price.”

Our name is an absolute guarantee of the best in quality and price.

Make our store your headquarters while in the city. You are always welcome.

Yours Respectfully,  
HOWARD & MORROW.

**SEEDS BY MAIL—WE DELIVER FREE, SEEDS IN PACKETS, OUNCES AND QUARTER POUNDS** when ordered by mail from this Catalog. When seeds in bulk are ordered by mail, postage must be added at the rate of 8 cents per lb. on half pound or over. 15 cents per quart for peas and beans and 10 cents per quart for corn.

**G**ARDENER'S and Head Farmer's Situations. We keep a register of names of Practical Gardeners and Farm Managers also Farm Laborers who are in want of situations. If parties desiring such will write to us we shall be glad to put them in communication with men that we deem suitable. To aid us in making a selection we ask full particulars, whether a married or single man is wanted, and the nature of the situation to be filled, also about what they expect to pay, and any other particulars. We make no charge for this service, either to employer or employee.

1910

# HOWARD & MORROW'S

GENERAL LIST OF

## Standard Tested Vegetable Seeds

"Our Seeds are Northern Grown, None Better at Any Price."

	Pkt.	Oz.	¼ Lb.	Qt.	Peck
ARTICHOKE,—Green Globe, . . . . .	.10	.35	\$1.00		
Jerusalem, (Roots), . . . . .				.25	\$1.25

**ASPARAGUS,—**

CULTURE.—Sow the seed thinly in rows 1 foot apart in April or May and keep down weeds; thin seedlings to 3 or 4 inches apart. One year old roots should be set out in spring, in rich sandy loam, dug 18 inches deep, work in plenty of well rotted manure. Every fall a good dressing of coarse manure and Quinipiac or Mapes' Fertilizers should be applied after tops are cut and in the spring forked in. Never cut closely.

PALMETTO,—The earliest good yielder, even and regular in growth, quality unequaled, . . . . .	Pkt.	Oz.	¼ Lb.		
	.05	.10	.20		
COLOSSAL,—The old standard variety, . . . . .	.05	.10	.20		
ASPARAGUS ROOTS,—Palmetto, (2 years old) . . . . .				per 100,	\$ .85
COLOSSAL, (2 years old) . . . . .				per 100,	.80

### BEANS

CULTURE.—When ground is perfectly warm and dry, make drill 2 inches deep and 18 inches to 2 feet apart; drop the beans 3 inches apart in the drills, cover not over 2 inches deep. Hoe well in dry weather. Sow every two weeks for succession. Compost, Mapes or Quinipiac Fertilizer may be thoroughly worked into soil before planting.

#### Dwarf Green Podded Varieties

**GIANT STRINGLESS GREEN POD,—**  
Very early, round pods absolutely stringless, fine quality, one of the finest string beans grown, 20c pt., 35c qt., \$1.25 ½ peck, \$2.00 peck.

**IMPROVED EARLY RED VALENTINE,—**  
One of the earliest beans in cultivation. Round pod. 15c pt., 30c qt., \$1.00 ½ peck, \$1.75 peck.



IMPROVED EARLY RED VALENTINE

**IMPROVED ROYAL WHITE OR KIDNEY**  
—Excellent for shelling green or baking when ripe, 15c pt., 25c qt., 75c ½ peck, \$1.25 peck.

**LARGE WHITE MARROW,—**The favorite for general field crop, 15c pt., 25c qt., 75c ½ peck, \$1.25 peck.

**HENDERSON'S BUSH LIMA,—**The earliest of the Bush Limas, very productive, requires no stakes or poles, quality excellent, 20c pt., 35c qt., \$1.25 ½ peck, \$2.00 peck.

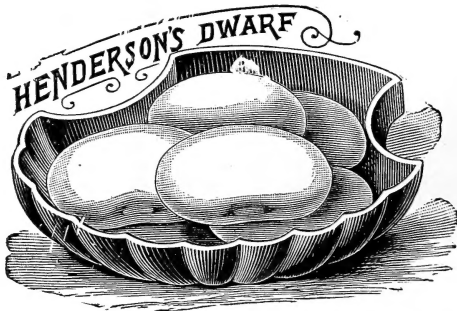

**BEANS—(Continued)—Dwarf, Green Podded Varieties**

**LONG YELLOW SIX WEEK**,—Very early, pods flat, green and very long, one of the most popular of its class, 15c. pt., 30c. qt., 85c. ½ peck, \$1.50 peck.

**EXTRA EARLY REFUGEE**,—Round pod, very productive, 15c pt., 30c qt., \$1.00 ½ peck, \$1.75 peck.

**BURPEE'S DWARF OR BUSH LIMA**,—A perfect bush form of the true lucious large Lima, grows from 18 to 20 inches high, stout and erect growth, immense, yielder, 20c pt., 35c qt., \$1.25 ½ pk., \$2.00 pk.

**BURPEE'S "IMPROVED" BUSH LIMA**,—An improvement on Burpee Bush Lima, 25c. pt., 45c. qt., \$1.50 ½ peck.

**DREER'S BUSH LIMA**,—20c pt., 35c qt., \$1.25 ½ peck, \$2.00 peck.

**EARLY CHINA RED EYE**,—Early and continues long in bearing, 15c pt., 30c qt., \$1.00 ½ peck, \$1.75 peck.

**EARLY MOHAWK**,—Long, flat and straight pods, very hardy, 15c. pt., 30c. qt., \$1.00 ½ peck, \$1.75 peck.

**FORDHOOK BUSH LIMA, (New)**—Both pods and beans are very large. 25c. pt., 45c. qt.

**HORTICULTURAL DWARF**, or "Dwarf Cranberry," late and productive, flat pod, 15c. pt., 30c. qt., \$1.00 ½ peck, \$1.75 peck.

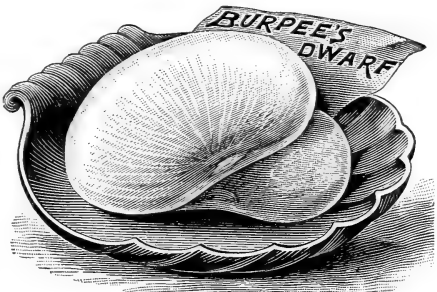

**Dwarf, Wax or Butter Varieties**

**GERMAN BLACK WAX**,—The old fashioned "Butter Bean,"—Black seed, very early, pods yellow, tender, and of the best quality, very popular, .20 .35 \$1.25 \$2.00

**CURRIE'S RUST PROOF WAX**,—(New), seeds black, pods yellow, flat and straight, said to be rust proof, .20 .35 \$1.25 \$2.00

**IMPROVED RUST PROOF GOLDEN WAX**,—An improvement on the old and popular Golden Wax, one of the standard varieties. The bean itself is light colored, doing away with whatever objection there may be to a dark bean, fully equal in quality to the Black Butter Bean.

Pt. Qt. ½Pk. Pk.  
.20 .35 1.25 2.00

**GOLDEN EYE WAX**,—Quite free from rust, early vigorous grower, hardy and prolific, flat pod, .20 .35 1.25 2.00

**KIDNEY WAX**,—Extra early, flat, purely wax pods, quite free from rust, .20 .35 1.25 2.00

**MICHIGAN WHITE WAX (New)**—A valuable white seeded variety, .20 .35 1.25 2.00

**REFUGEE WAX**,—The earliest wax variety, pods very tender, remaining so well through the season, heavy bearer, .20 .35 1.25 2.00

**HODSON WAX**,—Very large, tender wax pods; stringless. Enormously productive, .15 .30 1.00 1.75

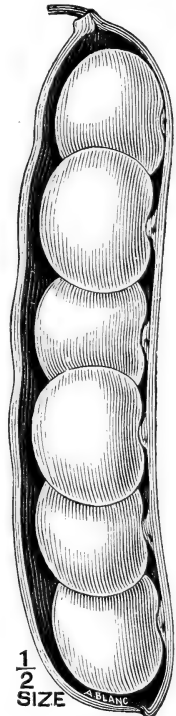

1/2 SIZE  
BLANC

EARLY JERSEY LIMA POLE

**Climbing, or Pole Varieties**

**CULTURE**.—Sow after danger from frost and soil is warm and dry, in hills 4 feet each way. Poles 8 or 10 feet long should be firmly set in hills before planting seed.

**GOLDEN CLUSTER WAX, —IMPROVED, —** Pods 6 to 8 inches long, golden yellow, flavor delicious, bears early, and lasts until late in the season, .20 .35 2.00

**BLACK WAX**,—Fine variety for string beans, pods yellow, .20 .35 2.00

**HORTICULTURAL OR CRANBERRY**,—A popular variety for shelling, 15 .30 1.75

**EARLY JERSEY LIMA**,—Fully two weeks earlier than the large Lima, and combines quality, quantity and earliness, .20 .35 2.00

"Our Seeds are Northern Grown, None Better at Any Price."

## BEANS—Climbing or Pole Varieties—Continued

	Pt.	Qt.	Pk.
DREER'S LIMA,—Thick, fine quality, . . . . .	.20	.35	\$2.00
KING OF THE GARDEN LIMA,—Heavy cropper, bean and pod very large, . . . . .	.20	.35	2.00
LARGE WHITE LIMA,—Extra large size, very tender and delicious, . . . . .	.20	.35	2.00
DUTCH CASE KNIFE,—Pods long, green and flat, an excellent shell bean, . . . . .	.15	.30	1.75
SCARLET RUNNERS,—Grown principally for ornament, scarlet blossom, . . . . .	.20	.35	
WHITE DUTCH RUNNERS,—Same habit as the scarlet, blossoms white, . . . . .	.25	.40	
OLD HOMESTEAD,—Probably the earliest of the green podded pole varieties, enormously productive, tender and nice, . . . . .	.20	.35	2.00

## BEETS—Table Varieties

CULTURE.—Sow as early as the ground can be worked and every two weeks after, up to the first week of July for a succession. For general crop sow after middle of May. Sow in drills, 1 foot to 15 in. apart, and when well up thin from 4 to 6 in. Soil should be light, sandy loam, well enriched—very little danger of getting too rich.



EARLY BLOOD  
TURNIP BEET

	Pkt.	Oz.	¼Lb.	Lb.
BASSANO,—Early flat,—An early, tender variety, color light, . . . . .	.05	.10	.20	.60
BASTIAN'S EARLY BLOOD TURNIP,—A good variety to follow Egyptian and Eclipse, . . . . .	.05	.10	.20	.60
CROSBY EGYPTIAN BEET,—An improvement on the original Egyptian, fully as early and a better keeper, . . . . .	.05	.10	.25	.80
CRIMSON GLOBE,—Selected. Rich deep crimson, fine quality, tender and sweet, globe shaped, . . . . .	.05	.10	.25	.75
DETROIT DARK RED TURNIP,—Round, skin dark blood-red, flesh bright red, . . . . .	.05	.10	.25	.75
DEWING'S BLOOD TURNIP,—Fine form and flavor, deep blood red, . . . . .	.05	.10	.25	.75
EARLY BLOOD TURNIP,—One of the best known and most popular sorts, deep blood red color, excellent quality, . . . . .	.05	.10	.20	.60
ECLIPSE BLOOD TURNIP,—Very early, one of the best, color bright red, . . . . .	.05	.10	.25	.75
EDMAND'S BLOOD TURNIP,—Second early, dark red, smooth, round . . . . .	.05	.10	.25	.70
LENTZ BLOOD TURNIP,—Very early, small top, round, dark red, . . . . .	.05	.10	.25	.70
LONG SMOOTH BLOOD,—Long smooth, dark red, late variety, . . . . .	.05	.10	.20	.60
SWISS CHARD OR SEA KALE BEET,—Grown exclusively for its leaves. The middle of the leaf can be used and served like asparagus, the rest like spinach, . . . . .	.05	.10	.20	.60

"Our Seeds are Northern Grown, None Better at Any Price."

**MANGEL-WURZEL**

CULTURE.—Mangels require deep soil to grow well. Plow and subsoil at least a foot to 18 in. Apply plenty of rich stable manure or Mapes or Quinnipiac Fertilizers. Sow latter part of May or in June (5 to 8 lbs. to acre), in rows not less than 18 inches apart and thin to 8 inches in the row. Young plants may be transplanted to fill up vacancies. When plants are 3 to 4 inches high sow 600 lbs. Quinnipiac or Mapes fertilizer to the acre. Cultivate and hoe well, keeping down weeds.



MAMMOTH PRIZE LONG RED

Oz. ¼Lb. Lb.

- MAMMOTH PRIZE LONG RED**,—  
One of the best for deep soil, roots very large, very heavy cropper, .05 .15 .40
- CHAMPION YELLOW GLOBE**,—  
Good keeper, smooth, globe shaped roots, .05 .15 .40
- GOLDEN TANKARD**,—Flesh bright yellow, said to contain a large amount of sugar, .05 .15 .40
- NORBITON GIANT**,—The largest variety grown, and one of the most popular, .05 .15 .40
- LANE'S IMPERIAL SUGAR**,—White fleshed, said to contain a large amount of sugar, .05 .15 .40

**BROCCOLI**

Pkt. Oz.

- WHITE CAPE**,—(Cultivation same as Cauliflower) one of the most certain to head, heads compact, creamy white, .10 .45

**BRUSSELS SPROUTS**

(Cultivation same as Cabbage.)

- IMPROVED DWARF**, — Compact heads, probably the best, .05 .20

**CAULIFLOWER**

CULTURE.—Same as cabbage except that an extra amount of fertilizer and plenty of water may be used to advantage.

- EARLY SNOWBALL**,—The best cauliflower grown, a sure header, Pkt. Oz. ¼Lb. .25 \$2.25 \$7.50
- EXTRA EARLY PARIS**,—A standard variety, .10 .60 1.75
- EARLY FAVORITE**,—An excellent, very early variety, .15 1.00 3.00

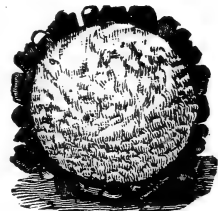

SNOWBALL CAULIFLOWER

## CABBAGE

**CULTURE.**—Soil for Cabbage should be rich heavy loam, with good drainage. Use an abundance of stable, Mapes or Quinnipiac Fertilizers, worked well into the soil. Sow in hot beds, transplanting in the spring as soon as the ground can be worked, 2 ft. apart one way and 12 to 18 in. the other, according to variety. For late crops, sow in May, transplant in July. If desired to cultivate with horse, set in rows of 2 ft. by 3 ft.



ALL SEASONS CABBAGE

**ALL SEASONS**,—Fine strain. Heads deep. Can be planted for early or late crop, 5c. pkt., 20c. oz., 60c.  $\frac{1}{4}$  lb., \$2.00 lb.  
**AUTUMN KING**,—One of the finest of late cabbages, excellent keeper, 5c. pkt., 25c. oz., 75c.  $\frac{1}{4}$  lb., \$2.50 lb.  
**CHARLESTON LARGE WAKEFIELD**,—About one week later than the Early Jersey Wakefield, but fully one half larger, 5c. pkt., 30c. oz., 90c.  $\frac{1}{4}$  lb., \$3.00 lb.  
**EXCELSIOR LATE FLAT DUTCH**,—A valuable late variety, one of the best for main winter crop, 5c. pkt., 20c. oz., 60c.  $\frac{1}{4}$  lb., \$2.00 lb.

	Pkt.	Oz.	$\frac{1}{4}$ Lb.	Lb.
<b>FOTTLER'S IMPROVED BRUNSWICK</b> ,—Fine large head, early, planted late makes excellent winter variety,	.05	.20	.60	\$2.00
<b>IMPROVED EARLY SUMMER</b> ,—Ten days later than Jersey Wakefield, large heads, excellent second early,	.05	.20	.60	2.00
<b>SUCCESSION IMPROVED</b> ,—Ten days later than early Summer, very large, sure header, good keeper and fine quality,	.05	.25	.75	2.50
<b>MAMMOTH ROCK RED</b> ,—Largest and surest header, red,	.05	.20	.60	2.00
<b>SELECTED EARLY JERSEY WAKEFIELD</b> ,—The earliest cabbage, heads cone shaped and solid,	.05	.30	.90	3.00
<b>EARLY WINNINGSTADT</b> ,—About three weeks later than Jersey Wakefield, heads cone shaped and solid, sure to head,	.05	.20	.45	1.50
<b>STONE MASON DRUMHEAD</b> ,—Large Firm heads, fine quality, late,	.05	.20	.60	2.00
<b>DRUMHEAD SAVOY</b> ,—Very tender, excellent flavor, fine,	.05	.20	.60	2.00
<b>SUREHEAD IMPROVED</b> ,—Large firm heads, late, good main crop,	.05	.20	.60	2.00
<b>HOLLANDER OR DANISH BALL HEAD</b> ,—Medium size heads, solid, best keeping cabbage grown,	.10	.30	.90	3.00

## CARROTS

**CULTURE.**—Sow from middle of May to first of July, in rows 10 in. apart for early and 14 for main crop, or further apart if it is desired to cultivate with horse. Thin out to 5 in. in rows for early crop, 6 to 7 in. for main crop. Soil, light, sandy loam, deeply dug, richly manured, hoe often, cultivate deep  
**OXHEART OR GUERANDE**,—Roots short and very thick, intermediate between Scarlet Horn and Half Long, 5c pkt., 15c oz., 35c  $\frac{1}{4}$  lb., \$1.00 lb.

**DANVER'S HALF LONG**,—(Pointed), heavy yielder, roots 8 to 10 inches long, thick, dark orange, 5c pkt., 15c oz., 35c  $\frac{1}{4}$  lb., \$1.00 lb.

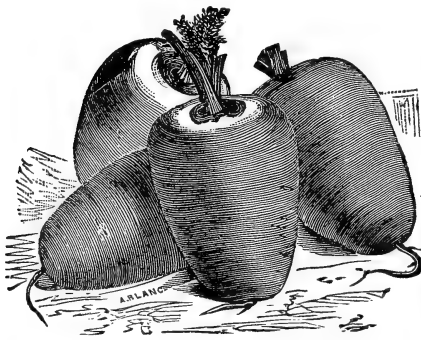

NEW OXHEART CARROT

**CARROTS—(Continued)**

- DANVER'S HALF LONG**,—(Stump rooted), similar to above excepting that it has blunt roots, 5c. pkt., 15c. oz., 35c. ¼ lb., \$1.00 lb.
- EARLY SCARLET HORN**,—An early variety, deep orange, blunt root, 6 to 8 in., 5c. pkt., 15c. oz., 35c. ¼ lb., \$1.00 lb.
- |   |      |     |      |        |
|---|------|-----|------|--------|
| <b>FRENCH FORCING</b> ,—Small round root, the earliest variety, . . . . . | Pkt. | Oz. | ¼Lb. | Lb.    |
|   | .05  | .15 | .40  | \$1.25 |
- INTERMEDIATE**,—Similar in shape to Danvers pointed, color deep orange, nearly coreless, good cropper, . . . . .
- |  |     |     |     |      |
|--|-----|-----|-----|------|
|  | .05 | .15 | .35 | 1.00 |
|--|-----|-----|-----|------|
- IMPROVED LONG ORANGE**,—The best general crop in deep soil, excellent for stock or table, . . . . .
- |  |     |     |     |     |
|--|-----|-----|-----|-----|
|  | .05 | .10 | .25 | .80 |
|--|-----|-----|-----|-----|

**CELERY**

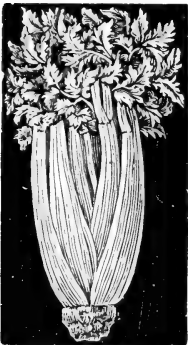

**CULTURE**.—Sow seed in light rich soil, as early as ground can be worked, in drills 8 or 10 inches apart, cover seeds about a quarter of an inch deep, rolling or treading them if ground is dry. When fairly out of seed leaf transplant or thin from 6 to 8 inches apart in the row, and let grow until wanted to plant out. Keep well wet down in dry weather. Set out in July, 6 to 8 inches apart, (press soil firmly against roots), in single row in shallow trenches, having previously worked a good quantity of well rotted manure in bottom of trench. It is well to work thoroughly into the soil under and around the trench a quantity of Mapes or Quinnipiac Fertilizers. To raise good celery requires rich soil. Earth up two or three times taking care not to let the earth get into the heart of the plant.

**IMPROVED WHITE PLUME**,—One of the easiest to raise as it requires no "banking up." Early and attractive, . . . . .

	Pkt.	Oz.	¼Lb.
	.10	.25	.75

- DWARF GOLDEN HEART**,—Very solid golden yellow heart, excellent keeper, fine flavor, . . . . .
- |  |     |     |     |
|--|-----|-----|-----|
|  | .05 | .20 | .50 |
|--|-----|-----|-----|
- DWARF GOLDEN SELF BLANCHING**,—One of the best for early, solid, fine nutty flavor, good size, golden yellow, . . . . .
- |  |     |     |      |
|--|-----|-----|------|
|  | .10 | .50 | 1.75 |
|--|-----|-----|------|
- GIANT PASCAL**,—The largest variety grown, fine nutty flavor, excellent keeper, easily blanched, . . . . .
- |  |     |     |     |
|--|-----|-----|-----|
|  | .05 | .20 | .50 |
|--|-----|-----|-----|
- WINTER QUEEN**,—Very large, blanches well, excellent keeper, . . . . .
- |  |     |     |     |
|--|-----|-----|-----|
|  | .05 | .20 | .60 |
|--|-----|-----|-----|
- PINK PLUME**,—Identified with White Plume but with stalk suffused with pink, very attractive, . . . . .
- |  |     |     |     |
|--|-----|-----|-----|
|  | .05 | .25 | .75 |
|--|-----|-----|-----|
- BOSTON MARKET**,—Very popular, a strong grower, tender and crisp, . . . . .
- |  |     |     |     |
|--|-----|-----|-----|
|  | .05 | .20 | .50 |
|--|-----|-----|-----|
- SOUP CELERY**,—(Old seed for flavoring), . . . . . 5c. oz., 15c. ¼ lb., 35c. lb.

**CELERIAC—(Turnip Rooted Celery)**

**CULTURE**.—Similar to celery but needs no hilling up.

**LARGE SMOOTH PRAGUE**,—An improved variety, round, smooth roots, the largest and best variety, 5c. pkt., 20c. oz., 50c. ¼ lb.

**CHERVIL**

**CULTURE**.—Same as parsley.

**CURLED**,—The leaves are used for flavoring, 5c. pkt., 20c. oz.

**CHICORY**

**CULTURE**.—Sow in June, transplant in autumn into sand in cellar.

**LARGE ROOTED**,—5c. pkt., 10c. oz., 30c. ¼ lb., \$1.00 lb.

**CORN SALAD OR FETTICUS**

**CULTURE**.—Sow in August in drills ¼ in. deep, 6 in. apart, keep down weeds. Just before winter cover thinly with straw or leaves.

**LARGE GREEN CABBAGING**,—A small, hardy, salad, used also as a substitute for lettuce, 5c. pkt., 10c. oz., 20c. ¼ lb., \$1.00 lb.

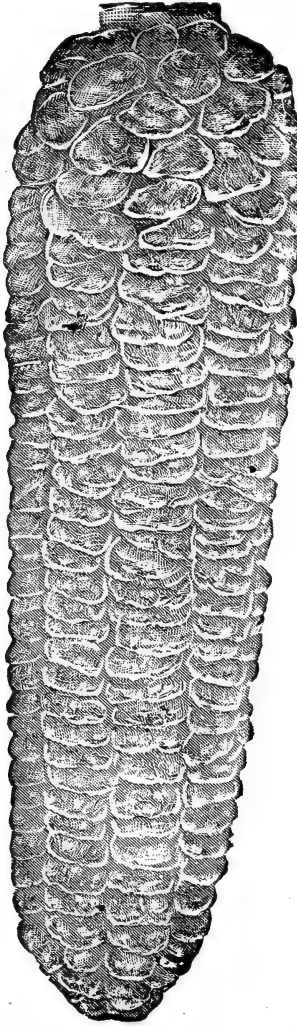

## CORN—(Sweet or Sugar)

**CULTURE.**—Plant in hills 3 ft. apart each way, and five or six kernels in a hill. Hoe often, drawing soil up to stem after first hoeing. Break off side shoots. Make ground very rich. If stable manure is used, it is perhaps best to plow it under. Use broadcast or in the hill Mapes or Quinipiac Fertilizer, worked well into soil. It has been found very beneficial to sow these fertilizers between the rows before cultivating and hoeing the second time.

We have been very careful in selecting the best and sweetest varieties of corn adapted to this section. The list below is arranged in order as they would mature. If two or more varieties are selected and planted at same time, they would be ready for the table at different times, one following the other.

	Pt.	Qt.	½Pk.	Pk.
<b>CORY</b> ,—The earliest sweet corn grown, ears good size, cob red,	.15	.25	.75	1.25
<b>WHITE CORY</b> ,—Resembles ordinary Cory, but with white cobs,	.15	.25	.75	1.25
<b>GOLDEN BANTAM</b> ,—Small yellow ears delicious flavor,	.20	.35	.90	1.50
<b>MAMMOTH WHITE CORY</b> ,—An improvement in size and quality over the White Cory,	.15	.25	.75	1.25
<b>HOWARD &amp; MORROW'S PERFECTION</b> ,—This is a new variety, coming just after the Cory, large ear, white kernels and white cob, excellent quality, and decidedly the best of the very early varieties,	.15	.25	.75	1.25
<b>NEW PREMO</b> ,—Very early, large ears, fine quality,	.15	.25	.75	1.25
<b>CROSBY EARLY</b> ,—An old and popular variety, rather small ears, good quality,	.15	.25	.75	1.25
<b>MINNESOTA EARLY</b> ,—Very early and desirable, ears fair size, good quality,	.15	.25	.75	1.25
<b>SHAKER EARLY</b> ,—Large ears, excellent quality,	.15	.25	.75	1.25
<b>MOORE'S CONCORD</b> ,—Medium early large ears, excellent quality,	.15	.25	.75	1.25
<b>BLACK MEXICAN</b> ,—Medium early, black kernels,	.15	.25	.75	1.25
<b>POTTER'S EXCELSIOR</b> ,—Fine large ears, very sweet, deep grain, medium early,	.15	.25	.75	1.25
<b>COUNTRY GENTLEMAN</b> ,—A distinct variety, rather small ear, cob very small, but of delicious quality (late),	.15	.25	.75	1.25
<b>HICKOX IMPROVED</b> ,—An excellent variety,	.15	.25	.75	1.25
<b>STOWELL'S EVERGREEN</b> ,—The standard for quality, and the best known variety, remains a long time in suitable condition for boiling,	.15	.25	.75	1.25
<b>WHITE EVERGREEN</b> ,—New strain of Evergreen, pure white grain,	.15	.25	.75	1.25

## FODDER CORN

**SOUTHERN SHEEP TOOTH**,—A very heavy yielder, especially adapted for ensilage. Prices according to market.

**RED COB ENSILAGE**,—One of the very large growing varieties, stalks quite leafy, enormous yielder. Prices according to the market.

**LEAMING**,—Probably the best Ensilage Corn, grows very large,—in ordinary season produces an abundance of very large ears. Prices according to market.

**HICKOX SWEET**,—A very sweet variety, cattle will eat every part of it, grows about the size of Evergreen. Market price.

**SWEET FODDER**,—This is more or less a mixture but is excellent for sowing. Market price.



"Our Seeds are Northern Grown, None Better at Any Price."

**FIELD CORN**

CULTURE.—Same as Sweet Corn. Some prefer to plant in drills. Use "Quinnipiac" or "Mapes" Fertilizer, worked well into the soil when planting or before second hoeing.

**EIGHT ROWED AND TWELVE ROWED**,—In varieties that will mature in this section.

**POP CORN**

**RICE**,—On the ear,—selected for seed, Per lb., 10c  
**RICE**,—" " "—for popping, " " 6c

**CRESS, OR PEPPER GRASS**

CULTURE.—Sow curled variety thickly in shallow drills every two or three weeks. Cut often. Sow water cress in damp soil or along streams of water.

**EXTRA CURLED**,—Used as salad, Pkt. Oz. ¼Lb. Lb.  
 .05 .10 .20 .50  
**TRUE WATER CRESS**,—Grows along the banks of ponds and streams—a fine salad, .10 .35 1.25

**CUCUMBERS**

CULTURE.—For very early, sow seed in hotbeds upon pieces of sod. Transplant when danger from frost is over. For general crop, sow in open ground when danger from frost is over and again every two weeks for a succession. For pickles sow from middle of June to first week in July. Plant in hills 4 feet apart, making hills rich.

**TELEGRAPH**,—For growing in hotbeds or greenhouses, Pkt., 25c.  
**BOSTON PICKLING**,—One of the best for pickling, 5c pkt., 20c oz., 50c ¼ lb., \$1.50 lb.

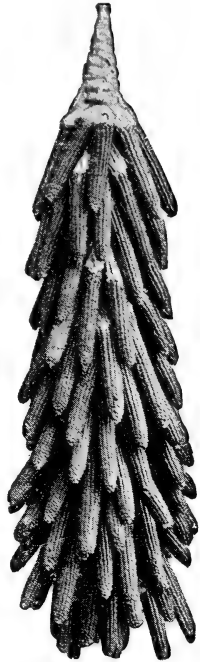

**COOL AND CRISP**,—New, very desirable for both pickling and slicing, 5c pkt., 20c oz., 50c ¼lb., \$1.50 lb.

**EARLY CLUSTER**,—A popular variety, grows in pairs, .05c pkt. 15c oz., 35c ¼ lb., \$1.25 lb.

**JAPANESE CLIMBING**,—Good for frames or open ground, 5c pkt. 15c oz., 35c ¼ lb., \$1.25 lb.

**EARLY FRAME**,—Early, good for pickling and slicing, 5c pkt., 15c oz., 35c ¼ lb., \$1.25 lb.

**EARLY RUSSIAN**,—Very early small, fine, 5c pkt., 10c oz., 30c ¼ lb., \$1.00 lb.

**IMPROVED LONG GREEN**,—The favorite for general crop, good pickler or slicer, 5c pkt., 20c oz. 50c ¼ lb., \$1.50 lb.

**NICHOL'S MEDIUM GREEN**,—Intermediate between Long Green and Frame, 5c pkt., 10c oz., 30c ¼ lb., \$1.00 lb.

**IMPROVED WHITE SPINE**,—One of the popular varieties, early, vigorous grower, crisp and fine flavor, 5c. pkt., 15c. oz., 35c. ¼ lb., \$1.25 lb.

**WEST INDIA GHERKIN (Small Burr)**,—Used exclusively for pickles, 10c. pkt., 30c. oz., 80c. ¼ lb., \$2.50 lb.

**DANDELION**

CULTURE.—Sow in early Spring in drills 1-2 in. deep and 18 in. apart, thin plants to 12 in. Keep clear of weeds. The leaves will be ready to cut the following spring. They are best if blanched, which can be done by placing two boards edgewise over the row.

**IMPROVED THICK LEAVED**,—Very much superior to the common dandelion for greens. Per pkt., 10c., oz. 35c.

"Our Seeds are Northern Grown, None Better at Any Price."

## EGG PLANT

**CULTURE.**—Sow in hot beds very early in spring, transplant when 2 in. high into second bed or small pots, or thin to 4 in. apart. Plant out after weather is perfectly settled and warm. Set plants 3 feet by 2 feet.

**NEW YORK IMPROVED SPINELESS,**—The earliest and probably the best, 10c. per pkt., 40c. per oz., \$1.25 per  $\frac{1}{4}$  lb.

## ENDIVE

**CULTURE.**—Sow in June, July or August, cover lightly, thin, to 8 in. apart. Water well if dry. When leaves are 6 or 8 in. blanch by tying together near top, at approach of winter take up with ball of earth and put in cool dry cellar. Handling of plants must be done when perfectly dry.

**GREEN CURLED,**—The popular variety, one of the best salads for fall and winter use, 5c. pkt., 15c. oz., 30c.  $\frac{1}{4}$  lb., \$1.00 lb.

**MOSS CURLED,**—5c. pkt., 15c. oz., 30c.  $\frac{1}{4}$  lb., \$1.00 lb.

## GOURDS

**FANCY VARIETY MIXED,**—5c. pkt., 20c. oz.

## Kale or Borecole

**CULTURE.**—Same as cabbage.

**DWARF GREEN CURLED SCOTCH,**—Grown for winter greens, 5c. pkt., 10c. oz., 30c.  $\frac{1}{4}$  lb., \$1.00 lb.

## KOHL RABBI—or Turnip Rooted Cabbage

**CULTURE.**—Sow in Spring in rows 18 in. apart, thin to 8 or 10 in., when thickened stems are 2 or 3 in. through above ground they are ready to eat and should be used at once. Cook same as turnips.

**PURPLE VIENNA,**—5c. pkt., 25c. oz., 65c.  $\frac{1}{4}$  lb.

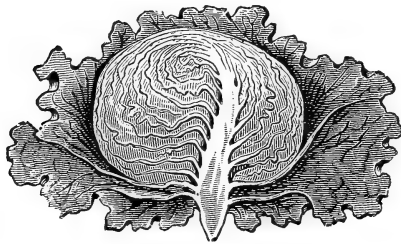

HANSON LETTUCE

## LETTUCE

**CULTURE.**—Sow in hot beds, and in open ground as soon as it can be worked, sow again in 2 weeks for succession. Transplant in rows 8 in. apart. Cos should be started very early in hot beds, and to blanch should be tied. Lettuce requires very rich ground well pulverized, in fact lettuce to be tender and crisp should have rapid growth, otherwise it will be tough and probably bitter.

	Pkt.	Oz.	$\frac{1}{4}$ Lb.
<b>BIG BOSTON,</b> —About twice the size and one week later than The Boston Market, produces large solid heads,	.05	.20	.50
<b>BOSTON MARKET,</b> —Edges slightly tinged with red, good forcing or out-door variety,	.05	.20	.50
<b>GRAND RAPIDS,</b> —One of the best forcing varieties, strong, grower, tender, crisp and retains its freshness a long time after being cut,	.05	.20	.50
<b>GOLDEN QUEEN,</b> —Medium size, golden yellow, solid heads, early,	.05	.20	.50
<b>HANSON IMPROVED,</b> —Outer leaves green, inner white, sure header, excellent quality, very satisfactory,	.05	.20	.50
<b>NEW YORK CABBAGE,</b> —Not a forcing variety but one of the best summer lettuce, forms large heads,	.05	.20	.50
<b>MARBLEHEAD MAMMOTH,</b> —The largest header, light green and tender,	.05	.20	.50
<b>PHILADELPHIA BUTTER,</b> —Inner leaves yellow, heads solid,	.05	.20	.50
<b>PRIZE HEAD,</b> —Leaves green and red, thin, crisp and tender,	.05	.20	.50
<b>SALAMANDER,</b> —Heads compact, resists summer heat admirably, light green outside, white inside,	.05	.20	.50
<b>SILESIA EARLY CURLED,</b> —Early and tender, leaves yellowish green,	.05	.20	.50

**LETTUCE—(Continued)**

	Pkt.	Oz.	¼Lb.
<b>SIMPSON BLACK SEEDED</b> ,—Leaves yellow, good for forcing or sowing out of doors,	.05	.15	.50
<b>SIMPSON EARLY CURLED</b> ,—Good for forcing or open ground sowing, yellowish green,	.05	.15	.50
<b>TENNIS BALL, BLACK SEEDED</b> ,—Forms handsome hard head, crisp and tender,	.05	.15	.50
<b>TENNIS BALL, WHITE SEEDED</b> ,—Excellent forcing variety, head firm, white and crisp,	.05	.20	.50
<b>TRIANON COS OR ROMAINE</b> ,—Self closing, an excellent variety, bleaches white, very crisp and tender,	.05	.20	.50
<b>WHITE PARIS COS</b> ,—Has long, narrow leaves, does not head, but when tied up blanches very nicely,	.05	.20	.50

**LEEK**

**CULTURE**.—Sow very early in drills 6 inches apart and 1 inch deep. Thin to 1 inch. When 7 inches high, transplant in rows 12 inches apart, deep as possible without covering center leaves. Water well if dry when planted out. Draw soil up to them as they grow. Rich soil is necessary.

**BROAD AMERICAN FLAG**,—By far the best variety grown, 5c. pkt., 20c. oz., 50c. ¼ lb.

**MUSK MELON**

**CULTURE**.—Light, sandy soil, very rich, plant when ground is dry and warm, in hills from 4 to 6 feet apart each way, 10 or 12 seeds to a hill. When well up and danger from insects is past, thin to 3 or 4 plants to hill. Pinch ends of growing shoots to induce early fruiting.

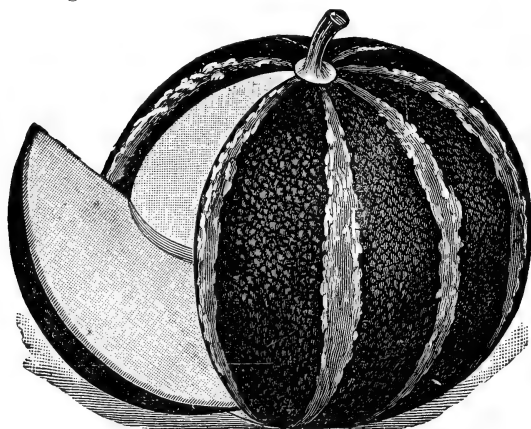

**HACKENSACK EXTRA EARLY IMPROVED**, — Quality perfect, very early, popular in this section, 5c pkt., 20c oz., 60c ¼ lb.

**EMERALD GEM**,—Medium size, skin smooth, deep green flesh salmon, delicious flavor, 10c pkt., 25c oz., 75c ¼ lb.

**GOLDEN NETTED GEM**, — Round, very early, delicious, 5c pkt., 20c oz., 50c ¼ lb.

**MILLER'S CREAM**,—Delicious flavor, flesh thick, salmon pink, 5c pkt., 20c oz., 50c ¼ lb.

**MONTREAL NUTMEG**,—Excellent variety, large size, flesh melting and of delicious flavor 5c pkt., 20c oz., 60c ¼ lb.

**ROCKY FORD**,—Netted, very sweet and fine flavored, 5c. pkt., 15c. oz., 35c. ¼ lb.

**SURPRISE**,—One of the best for this section, flesh deep salmon, thick and fine flavor, 5c. pkt., 20c. oz., 60c. ¼ lb.

**YELLOW FLESHED OSAGE**,—Very fine, thick fleshed, good keeper, 5c. pkt., 20c.oz., 60c. ¼ lb.

**WATER MELON**

**CULTURE**.—Same as Musk Melon, only plant further apart, about 8 or 10 feet.

**PHINNEY'S EARLY**,—Very early, fine quality, excellent variety for this section, Pkt. Oz. ¼Lb.

**MOUNTAIN SWEET**,—Early, oblong, dark green, flesh red, solid, sweet, .05 .10 .25

**CITRON**,—For preserving, .05 .10 .25

**MUSTARD**

**CULTURE**.—Sow thickly during early spring in shallow drills. Sow early in September for fall salad.

**BLACK OR BROWN**,—For salads, 5c. oz., 10c. ¼ lb., 25c. lb.

**WHITE LONDON**,—For salads, 5c. oz., 10c. ¼ lb., 25c. lb.

"Our Seeds are Northern Grown, None Better at Any Price."

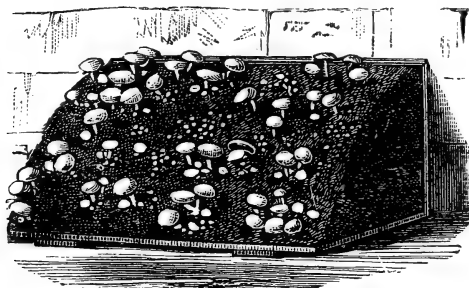

MUSHROOM BED

## MUSHROOM SPAWN

**CULTURE.**—Mushrooms are more easily cultivated than many people imagine and may be grown in any room or cellar where the temperature can be maintained at from 50 to 65 degrees. For the beds use a mixture of three parts horse droppings and one part good fresh loam. Before being placed in the bed, let the manure be put in some dry place to sweeten, mixing it thoroughly and turning it three or four times, when the loam may be added.

Upon a dry firm bottom or shelf, make the bed by spreading a thin layer of the prepared mixture, pounding it firm, and continue this, till the bed is twelve inches thick. Leave it thus for about a week, or until the temperature has subsided to 85 degrees. Then make holes about ten inches apart, and put in each a piece of spawn about the size of an egg. Press the spawn firmly into the compost about two inches, leaving the top uncovered to allow the excess of heat and moisture to pass off without injury to the germs. After ten days, fill the holes and cover the whole bed with two inches of fresh loam, and over this place a few inches of straw. If the temperature is right, mushrooms will appear in six or eight weeks from the time of spawning. The bed will continue bearing from four to six weeks. If the surface of the bed becomes dry at any time, it should be moistened freely with water at a temperature of eighty to eighty-five degrees.

Our stock of spawn is replaced a number of times during the season and is giving excellent results.

**ENGLISH,**—15c. lb., 10 lbs. for \$1.00.

**AMERICAN,**—In bricks, per brick 18c. 10 bricks \$1.50.

## NASTURTIUM—(See Flower Seed)

## OKRA OR GUMBO

**CULTURE.**—Sow late in Spring when ground is warm, in drills 3 ft. apart, thin from 9 to 12 in. They should be well manured.

	Pkt.	Oz.	¼Lb.	Lb.
<b>DWARF WHITE VELVET,</b> —Pods round, smooth and white, very prolific,	.05	.10	.20	.50
<b>DWARF GREEN,</b> —Very early,	.05	.10	.20	.50

## ONIONS

**CULTURE.**—Sow in rich light soil in drills 1 ft. apart (or wider if to be cultivated with horse), as soon as ground can be worked, thin to 3 or 4 inches, hoe or rake frequently to keep down weeds. Use Mapes or Quinipiac Fertilizers.

**BARLETTA,**—Early, mild, fine, 5c pkt., 20c oz., 60c ¼ lb., \$2.00 lb.

**Yellow Globe Danvers** Our Finest Strain

This seed is grown from the very earliest and best selected Onions, and is very much superior to the average seed offered.—The yellow Globe Danvers is the standard variety, good yielder, excellent keeper, 5c pkt., 20c oz., 60c ¼ lb., \$2.00 lb.

**YELLOW GLOBE DANVERS,**—Fine Strain,—While this is not equal to our finest strain, it is fully equal to most Onion seed, and the same that is usually sold by dealers, 5c pkt., 15c oz., 50c ¼ lb., \$1.75 lb.

**EXTRA EARLY FLAT RED,**—Very early, medium size, mild, 5c. pkt., 20c. oz., 65c. ¼ lb., \$2.25 lb.

**NEW QUEEN,**—Rapid grower, mild flavor, white, 5c. pkt., 20. oz., 60c. ¼ lb., \$2.00 lb.

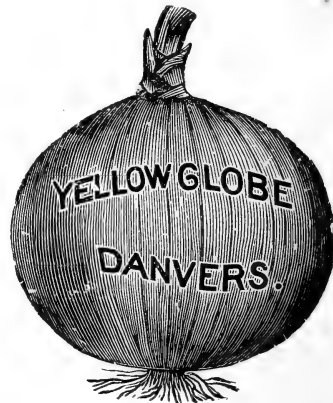

"Our Seeds are Northern Grown, None Better at Any Price."

**ONION SEED**



- LARGE RED WETHERSFIELD**,—Large yielder, good keeper, 5c pkt., 25c oz., .75c ¼ lb., \$2.50 lb.
- PRIZETAKER**,—Bulbs very large, uniform, very productive, flavor mild, color, bright straw, choice American stock, 5c pkt., 25c oz., 65c ¼ lb., \$2.25 lb.
- WHITE PICKLING**,—The best for pickling, 5c pkt., 20c oz., 65c ¼ lb., \$2.25 lb.
- SOUTHPORT WHITE GLOBE**,—Large, firm, fine grained, mild flavor, 10c pkt., 35c oz., \$1.00 ¼ lb., \$3.00 lb.
- SOUTHPORT YELLOW GLOBE**,—Same as White except in color, 5c pkt., 20c oz., 60c ¼ lb., \$2.00 lb.
- WHITE PORTUGAL OR SILVERSKIN**,—A flat white onion, fine grained, good keeper, 5c pkt., 25c oz., 75c ¼ lb., \$2.25 lb.

**HOWARD & MORROW'S EXTRA EARLY RED GLOBE**,—Ten days earlier than Southport Red Globe, color beautiful bright red, 5c pkt., 25c oz., 75c ¼ lb., \$2.50 lb.

**ONION SETS**

	Qt.	½Pk.	Pk.	Bu
White, price subject to change,	.25	.75	1.25	4.50
Yellow, price subject to change.	.20	.65	1.00	3.50
Multipliers, or Shallots,	.20			

**PARSLEY**

**CULTURE**.—Soak seed a few hours in warm water, sow early, and until the middle of July in drills 1 ft. apart. Thin to 4 in. For winter use, transplant to light cellar.

**CHAMPION MOSS CURLED**,—Beautifully crimped and curled, 5c pkt., 10c oz., 20c ¼ lb., 60c lb.

**FINE DOUBLE CURLED**,—A standard variety, finely curled leaves, 5c. pkt., 10c. oz., 20c. ¼ lb., 60c. lb.

**FERN LEAVED**,—Has a feathery fern-like appearance, 5c. pkt., 10c. oz., 25c. ¼ lb., 75c. lb.



CHAMPION MOSS CURLED PARSLEY

**PARSNIP**

**CULTURE**.—Sow in drills 18 in. apart as soon as ground can be worked in Spring. in rich soil, well and deeply dug. Thin to 6 or 8 in. Keep weeds down.

	Pkt.	Oz.	¼Lb.	Lb.
<b>LONG SMOOTH WHITE</b> ,—Standard variety, long, smooth, white roots.	.05	.10	.20	.50
<b>HOLLOW CROWNED</b> ,—An excellent variety, fine quality,	.05	.10	.20	.50
<b>STUDENT</b> ,—Fine strain, with long smooth roots.	.05	.10	.20	.50

**PEAS**

**CULTURE**.—For Peas, light, dry soil is best. Sow as early as ground can be worked, and again every ten days for succession. Peas may be sown as late as August 15th. Medium and late Peas must be planted early. Early Peas may be planted early or late, and the extra early very late. Sow in single or double rows from 4 to 6 feet apart, according to variety, and about an inch apart in the row and 4 in. deep. Hoe often, keep ground clean and fine. Most Dwarf Peas will bear better if bushed enough to keep them from the ground. If the pea louse attacks the vines, spray every day with clear water using force. Another remedy is whale oil soap. Dissolve one pound in 7 to 10 gallons water and apply with sprinkling pot or syringe.

"Our Seeds are Northern Grown, None Better at Any Price."

**PEAS—(Continued)—Extra Early Dwarf Varieties**

This mark (\*) indicates Wrinkled varieties; Height in ft. Pt. Qt.  $\frac{1}{2}$ Pk Peck Bush.

\***BLISS AMERICAN WONDER**,—Fine quality, very early, 1 1/4 .20 .35 \$1.25 \$2.00 \$7.00

\***PREMIUM GEM**,—An improvement on Little Gem, fine variety, 1 1/4 .15 .30 1.00 1.75 6.50

\***NOTT'S EXCELSIOR**, New,—Fine quality, very early, good yielder, 1 1/4 .20 .35 1.25 2.00 7.00

\***SUTTON'S EXCELSIOR**,—Similar to Nott's larger pods, 1 .20 .35 1.25 2.00 7.50

**HOWARD & MORROW'S PERFECTION DWARF**

This is a fine variety, very early, quality excellent. It is a round blue pea and is a sure crop, much more so than the Gem or Wonder, especially in heavy soils, height 1 1/2 feet. 20c pint, 35c qt. \$1.25 1/2pk., \$2.00 pk., \$7.00 bush.

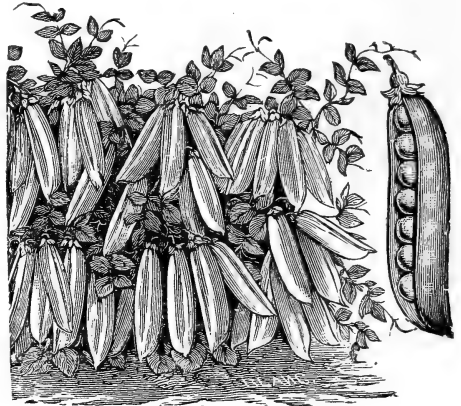

**Extra Early Varieties—Not Dwarf**

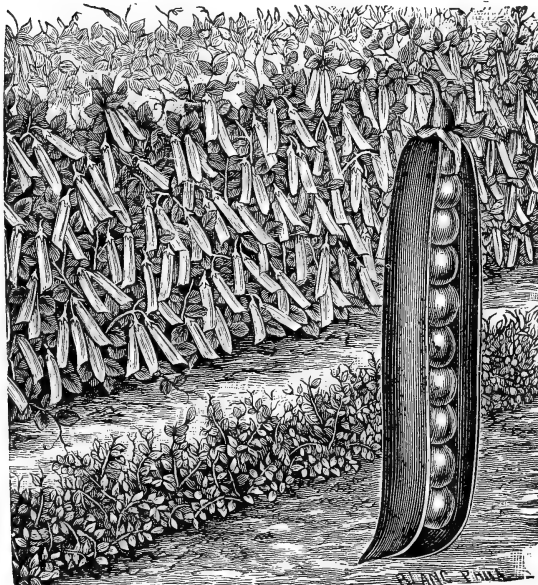

**HOWARD & MORROW'S EXTRA EARLY**

One of the very earliest peas grown, ripens evenly, pods well filled, in quality and productiveness it is fully equal to any of the early smooth sorts, height 2 1/4 feet, pint 15c., quart 30c., 1/2pk., \$1.00, peck \$1.75, bushel \$6.50.

ALASKA,—The earliest blue pea, fine sort. Height in ft. Pt. Qt.  $\frac{1}{2}$ Pk Peck Bush

\***GRADUS**,—(Prosperity),—One of the finest extra early peas yet introduced. It is in condition to pick about five days after our Extra Early, pods large, well filled with wrinkled deep green peas, 3 .25 .45 1.50 2.50 9.00

\***SURPRISE OR ECLIPSE**,—A fine wrinkled variety, about five days later than our Extra Early, 2 .20 .35 1.25 2.00 7.00

“Our Seeds are Northern Grown, None Better at Any Price.”

**PEAS—(Continued)—Extra Early Varieties**

	Height in feet.	Pt.	Qt.	½Pk.	Pk.	Bush.
*THOMAS LAXTON,—Very early and productive, pods large, finest flavor,	3	.25	.40	\$1.50	\$2.50	\$7.00
PHILADELPHIA EXTRA EARLY,—	2½	.15	.30	1.00	1.75	6.50
FIRST AND BEST,—A standard early variety,	2½	.15	.30	1.00	1.75	6.50
IMPROVED DAN'L O'ROURKE,—A reliable early sort,	2½	.15	.30	1.00	1.75	6.50

**Second Early Varieties**

*DAISY (Dwf. Telephone)—An excellent new variety, large, well filled pods, fine flavor,	1½	.20	.35	1.25	2.25	8.00
*ABUNDANCE,—Bears numerous well filled pods, excellent quality,	1½	.15	.30	1.00	1.75	6.50
*EVERBEARING,—Remains long time in bearing, peas large, pods long, fine flavor,	2½	.15	.30	1.00	1.75	6.50
*NEW DWARF CHAMPION,—Very productive, large peas, delicious flavor,	2	.20	.35	1.25	2.00	7.00
*HEROINE,—New, heavy bearer, large peas, fine flavor,	2¼	.20	.35	1.25	2.00	7.00
*HORSFORD'S MARKET GARDEN,—On the style of Advancer, peas sweet and delicious,	2½	.20	.35	1.25	2.00	7.00
*McLEAN'S ADVANCER,—A fine and popular variety,	2½	.20	.35	1.25	2.00	7.00
*STRATAGEM IMPROVED,—Heavy cropper, delicious flavor, large handsome pods,	2	.20	.35	1.25	2.25	7.50
*YORKSHIRE HERO,—An excellent yielder, fine quality,	2½	.15	.30	1.00	1.75	5.50

**Tall Late Varieties**

*ALDERMAN,—(New) Extra large pods on order of Duke of Albany, very fine,	4	.15	.30	\$1.00	\$1.75	\$6.50
*AMERICAN CHAMPION (DUKE OF ALBANY),—A trifle earlier than the Champion of England, fine variety, should be sown thinly,	4	.20	.35	1.25	2.00	7.00
*CHAMPION OF ENGLAND,—One of the richest. best flavored peas, well known and popular,	5	.20	.35	1.25	2.00	6.50
*IMPROVED TELEPHONE,—Very fine strain, pods very large, well filled, quality excellent,	4	.20	.35	1.25	2.25	8.00
CANADA FIELD,—Principally sown for feeding stock, market price,						
BLACK-EYED MARROWFAT,—An old time favorite,	5	.15	.25	.75	1.25	4.00
WHITE MARROWFAT,—Similar to above,	5	.15	.25	.75	1.25	4.00
SUGAR, MAMMOTH MELTING,—Edible pods.	4	.25	.40			

**POTATOES**

CULTURE.—So many conflicting opinions exist as to the best method of growing potatoes, that we do not venture to give directions for culture. We do however make the following suggestions: Plant in such a manner that most of the heavy hard work can be done by the horse. Use “Mapes Potato Manure,” or “Quinnipiac Potato or Market Garden,” in sufficient quantities to insure a crop. Always bear in mind that to get the full benefit of the fertilizer and not burn the roots it should be thoroughly mixed with the soil. If stable manure is used at all it should not come in contact with the tubers, as it is sure to make the crop rough and scabby.



These Potatoes were raised from our Maine Grown Seed, the crop was uniform and heavy and of excellent quality.

## POTATOES

The Potatoes marked \* were grown specially for seed, in Maine, **No Paris Green was used**, no blight, scab or rot appeared, the potatoes growing to full development. Bug death being used as an insecticide.

Use the "Quinnipiac or Mapes Fertilizers."—To insure quantity and quality in your potato crop **there are positively no better fertilizers made.**

### Prices subject to Variation

These are the prices ruling in January—later on they may be higher.

	½Pk.	Pk.	Bu.	Bbl.
* <b>NORCROSS</b> ,—New, late, white, oval, standard Maine crop,	.45	.80	2.50	5.25
* <b>SNOW</b> ,—New, medium late, white, oblong, fine quality, heavy yielder,	.45	.80	2.50	5.25
* <b>EARLY JOHNSON</b> ,—New, early, pink, long, excellent quality,	.60	1.00	3.00	6.50
* <b>STAR OF THE EAST</b> ,—New, medium early, oblong, large yielder, fine table potato,	.45	.85	2.75	5.75
* <b>GREEN MOUNTAIN</b> ,—New, oval, white, excellent, heavy yielder,	.40	.75	2.65	5.50
* <b>RICHMOND</b> ,—New, pink, medium late, fine, large yielder,	.45	.80	2.50	5.25
* <b>IRISH COBBLER</b> ,—Early, white round, productive,	.45	.80	2.50	5.25
<b>NEW QUEEN</b> ,—Early, resembles Beauty of Hebron, but a heavier yielder, one of the most popular potatoes grown,	.40	.65	2.00	4.50
<b>BOVEE</b> ,—Extra Early, very productive, of fine quality, white,	.40	.65	2.00	4.50
<b>EARLY ROSE</b> ,—A well known early variety,	.40	.65	2.00	4.50
<b>BEAUTY OF HEBRON</b> ,—An excellent and popular early variety,	.40	.65	2.00	4.50

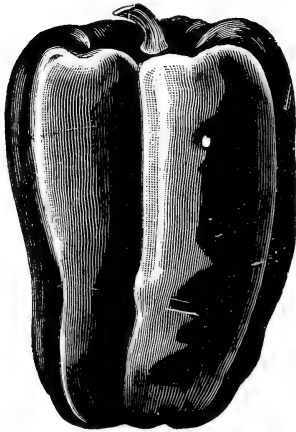

RUBY KING

## PEPPERS

**CULTURE.**—Sow in hotbeds in March, when soil is warm, set in rows 2 ft. and 18 in. in the row. Hoe frequently.

	Pkt.	Oz.	¼Lb.
<b>LARGE BELL OR BULL NOSE</b> ,—A favorite, large, mild, red,	.05	.25	.65
<b>LONG RED CAYENNE</b> ,—Small, long, bright red, extremely strong,	.05	.25	.65
<b>CHINESE GIANT</b> ,—Very large, flesh mild and thick, bright scarlet,	.10	.40	1.25
<b>RUBY KING</b> ,—Mild, very large and handsome,	.05	.25	.65
<b>SWEET MOUNTAIN</b> ,—Large and mild, a popular sort,	.05	.25	.65
<b>RED CHERRY</b> ,—Cherry shaped, for pickles,	.10	.25	.65

## PUMPKINS

**CULTURE.**—Same as for squash, or may be planted with corn.  
**CONNECTICUT FIELD**,—The popular one for general crop,

	Qt.	Pk.	
	.20	\$1.25	
	Pkt.	Oz.	¼Lb.
<b>CUSHAW OR CROOKNECK</b> ,—Cream color, grows to a large size,	.05	.10	.25
<b>KING OF THE MAMMOTHS</b> ,—Grows very large, round, flat, yellow,	.05	.15	.35
<b>SWEET OR SUGAR</b> ,—Small, round, yellow, excellent for pies,	.05	.10	.20



“Our Seeds are Northern Grown, None Better at Any Price.”

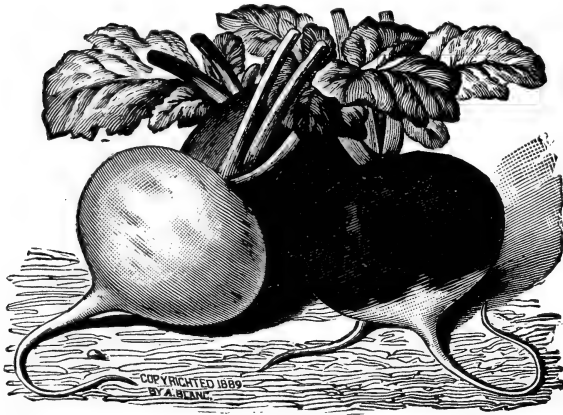

### RADISH

**CULTURE.**—Sow as soon as ground is dry, in rows 8 to 12 in. apart, and every 10 days after for succession, up to middle of June. Light, rich soil.

**EARLY ROUND DARK RED,**—Early, pleasant, flavored, 5c pkt., 10c oz., 25c ¼ lb., 70c lb.

**EARLY SCARLET TURNIP,**—Popular, quick grower, mild flavor, 5c pkt., 10c oz., 20c ¼ lb., 50c lb.

**SCARLET TURNIP, WHITE TIPPED,**—Very early, fine quality, 5c pkt., 10c oz., 20c ¼ lb., 60c lb.

**OLIVE SHAPED SCARLET,**—Early, flesh firm and crisp, 5c pkt., 10c oz., 20c ¼ lb., 60c lb.  
Pkt. Oz. ¼Lb. Lb.

**ROSY GEM,**—Globe shaped, deep scarlet on top blending to white on the bottom, very fine, .05 .10 .20 .60

**FRENCH BREAKFAST,**—Olive shaped, white tipped, popular, .05 .10 .20 .60

**SCARLET GLOBE,**—One of the earliest, good for forcing, or open ground culture, crisp and tender, .05 .10 .20 .60

**LONG SCARLET SHORT TOP,**—The old favorite, .05 .10 .20 .50

**CHARTIER,**—An excellent long variety, scarlet, .05 .10 .20 .60

**WHITE LADY FINGER OR VIENNA,**—The finest of the long, white radishes, .05 .10 .20 .60

**WHITE STRASBURG,**—Long summer variety of good quality, .05 .10 .20 .60

### Winter Radishes

**ROUND BLACK SPANISH,**—Skin black, globe shaped, tender, .05 .10 .20 .60

**LONG WHITE SPANISH,**—Skin white, mild, .05 .10 .20 .60

**ROSE CHINA WINTER,**—Rose colored skin, flesh white, quality excellent, .05 .10 .20 .60

### RHUBARB

**CULTURE.**—Sow seed in March in cold frame, keep from freezing, transplant to open ground in about 8 weeks, in rows 12 in. apart each way. The following spring transplant to 4 or 5 ft. apart each way. When roots are set out plant them 4 or 5 feet each way. Ground should be rich. Cover in fall with thick dressing of coarse manure, spade under in the spring.

**VICTORIA,**—A popular variety, 5c. pkt., 15c. oz., 40c. ¼ lb.

**ROOTS,**—Each 15c., \$1.50 doz.

### SALSIFY OR VEGETABLE OYSTER

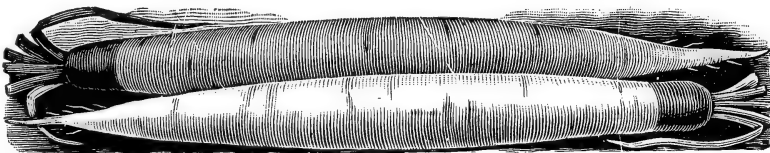

**CULTURE.**—Sow as early as ground can be worked in spring in drills 12 in. apart, 1 in. deep. Thin to 6 in. in row. Cultivate and treat as parsnips.

**MAMMOTH SANDWICH ISLAND,**—The best variety, 5c pkt., 15c oz., 40c ¼ lb., \$1.25 lb.

"Our Seeds are Northern Grown, None Better at Any Price."

### SPINACH

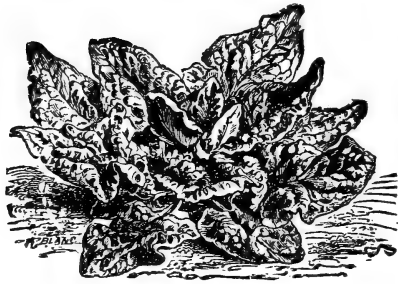

**CULTURE.**—Sow early in Spring in drills one ft. apart. As it grows thin out for use. For fall use sow in August. Sow New Zealand in hills two feet apart each way, three or four seeds in hill. This is fit for cutting all summer.

**BLOOMSDALE SAVOY LEAVED,**—Crinkled leaves, hardy, fine quality, 5c pkt., 10c oz., 15c ¼ lb., 35c lb.

**LARGE VIROFLAY,**—Leaves thick, roundish, heavy cropper, 5c pkt., 10c oz., 15c ¼ lb., 35c lb.

**LONG STANDING THICK LEAVED,**—Dark green, stands a long time before going to seed, 5c pkt., 10c oz., 15c ¼ lb., 35c lb.

	Pkt. Oz. ¼Lb. Lb.
<b>NEW ZEALAND,</b> —Should be started and transplanted, grows well during the hot weather. Seed should be soaked in hot water before sowing,	.05 .10 .30 .80
<b>THICK LEAVED ROUND,</b> —One of the best, leaves large, thick, crumpled,	.05 .10 .15 .35
<b>PRICKLY WINTER,</b> —	.05 .10 .15 .35

### SQUASH—Summer Varieties

**CULTURE.**—Sow in hills same time and manner as cucumbers and melons, the bush varieties 3 to 4 feet and running 6 to 9 feet.

**WHITE BUSH SCALLOP**—Very early good shipper, Pkt. Oz. ¼Lb. Lb. .05 .10 .25 .75

**YELLOW BUSH SCALLOPED,**—Same as above excepting color. .05 .10 .25 .75

**GIANT SUMMER CROOKNECK BUSH,**—The favorite summer variety, .05 .10 .25 80

**VEGETABLE MARROW,**—Summer and fall variety, outside yellow, flesh white, .05 .15 .25 .75

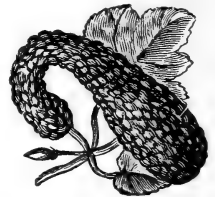

### Fall and Winter Varieties



**BOSTON MARROW,**—Fine fall variety, oval, bright orange, Pkt. Oz. ¼Lb. Lb. .05 .10 .25 .75

**DELICIOUS,**—Green skin, orange flesh, fine grained sweet and dry, .05 .15 .40 1.00

**IMPROVED HUBBARD,**—The leading variety, fine grained, dry, excellent flavor, .05 .15 .35 1.00

**IMPROVED MARBLEHEAD,**—Similar to Hubbard, a trifle earlier, .05 .15 .35 1.00

**MAMMOTH CHILL,**—Orange yellow, grows very large, .05 .15 .35 1.00

**SUNFLOWER,**—See Flower Seeds.

**TOBACCO,**—Connecticut Seed Leaf, 10c pkt., 25c oz.

"Our Seeds are Northern Grown, None Better at Any Price."

### TOMATO



**CULTURE.**—Sow thinly in March in hotbed or in boxes in the house, when 2 inches high set out plants in boxes, four inches apart or pot singly. If again transplanted before setting in the ground they will be benefited. Plant out about June 1st. Set deeply 4 feet each way. Make hills very rich. Support with frame work or train to stakes.

	Pkt.	Oz.	¼Lb.
<b>ACME</b> ,—Early, smooth, solid, color purplish red,	.05	.25	.75
<b>BEAUTY</b> , (Livingston's),—Large smooth, solid, purplish red,	.05	.25	.75
<b>CHALK'S EARLY JEWEL</b> ,—New, large, solid, smooth, bright red, very early,	.05	.25	.75
<b>FAVORITE</b> , (Livingston's),—Large, smooth, productive, good shipper,	.05	.25	.75
<b>PERFECTION</b> , (Livingston's),—Early, regular, productive, blood-red, few seeds,	.05	.20	.75
<b>DWARF CHAMPION</b> ,—Vine compact, and upright, very early, smooth, color same as Acme,	.05	.30	.85
<b>EARLIANA</b> ,—Extra early, bright red,	.05	.25	.75
<b>PONDEROSA</b> ,—One of the largest solid, good flavor, bright red,	.10	.40	1.25
<b>RED CHERRY</b> ,—Fruit small, about 5/8 inches in diameter, fine for preserves,	.10	.30	.85
<b>STONE</b> ,—Very solid, deep red, apple shape, large, good shipper,	.05	.30	.85
<b>YELLOW PLUM</b> ,—Plum shaped, deep yellow, fine flavored,	.05	.25	.75
<b>TROPHY</b> , Extra Selected,—A standard late sort,	.05	.25	.75
<b>CRIMSON CUSHION</b> ,—Very large, scarlet crimson, few seeds, fine new variety,	.10	.30	.85

### TURNIP



**CULTURE.**—For early turnips sow as soon as ground can be worked. For fall and early winter sow from middle of July to August. Sow Ruta Bagas in June or early in July in drills 18 in. apart, thin from 6 to 9 inches, soil should be rich and well worked. The early varieties may be sown broadcast, but Ruta Bagas should be sown in drills.

	Pkt.	Oz.	¼Lb.	Lb.
<b>EARLY SNOWBALL</b> ,—Round, medium size, fine quality,	.05	.10	.20	.60
<b>EARLY WHITE FLAT DUTCH</b> ,—Sweet and fine grained,	.05	.10	.20	.60
<b>EXTRA EARLY PURPLE TOP MILAN</b> ,—The earliest turnip grown,	.05	.10	.25	.75
<b>LONG WHITE COWHORN</b> ,—Roots carrot shaped, flesh firm, white and sweet,	.05	.10	.20	.60
<b>PURPLE TOP STRAP LEAVED</b> ,—The leading variety for sowing broadcast, good for stock or table use,	.05	.10	.20	.50
<b>IMPROVED GOLDEN BALL</b> ,—An excellent table variety, round, yellow fleshed, sweet and solid,	.05	.10	.20	.50
<b>WHITE EGG</b> ,—Good yielder, flesh firm, fine grained and sweet,	.05	.10	.20	.50
<b>YELLOW ABERDEEN</b> ,—Flesh pale yellow, tender, fine flavored,	.05	.10	.20	.50
<b>YELLOW GLOBE</b> ,—Good for general crop, grows large, good keeper,	.05	.10	.20	.50
<b>YELLOW STONE</b> ,—Good table variety, good keeper,	.05	.10	.20	.50

“Our Seeds are Northern Grown, None Better at Any Price.”

**TURNIP—(Continued)—Ruta Baga or Swedish Varieties**

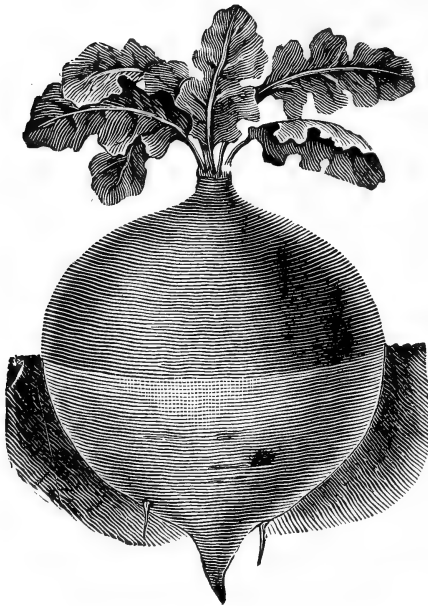

**IMPROVED AMERICAN PURPLE TOP,—**

The favorite yellow fleshed winter turnip  
5c pkt., 10c oz., 20c ¼ lb., 60c lb.

**LAING'S SWEDE,—**An early Ruta Baga,  
good for table or stock, 5c pkt., 10c oz.,  
20c ¼ lb., 50c lb.

**LONG ISLAND PURPLE TOP,—**One of the  
best, flesh yellow, solid, sweet, 5c pkt.,  
10c oz., 20c ¼ lb., 60c lb.

**SHAMROCK SWEDE,—**An excellent yellow  
fleshed variety, 5c pkt., 10c oz., 20c ¼ lb.,  
60c lb.

**SKIRVING'S PURPLE TOP,—**Yellow fleshed,  
good for stock or table use, 5c pkt., 10c  
oz., 20c ¼ lb., 50c lb.

**WHITE SWEDE,—**A superior white fleshed  
variety, 5c pkt., 10c oz., 20c ¼ lb., 50c lb.

**WHITE SWEET GERMAN,—**A fine sweet  
winter variety, good keeper, 5c pkt., 10c  
oz., 20c ¼ lb., 50c lb.

**HERBS**

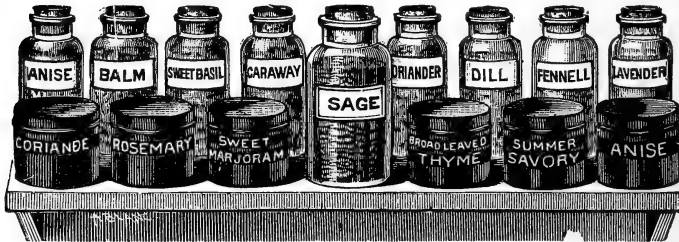

	Pkt	Oz.
ANISE,—For garnishing and flavoring . . . . .	.05	.10
BALM,—Used for making balm tea . . . . .	.05	.25
CARAWAY,—For flavoring . . . . .	.05	.10
CORIANDER,—For flavoring . . . . .	.05	.10
DILL,—For flavoring . . . . .	.05	.10
HOREHOUND,—Used for its tonic properties . . . . .	.05	.25
LAVENDER,—Leaves very fragrant . . . . .	.05	.30
ROSEMARY,—Leaves very fragrant . . . . .	.10	.40
RUE,—Used for medicinal purposes . . . . .	.05	.30
SAGE,—A medicinal and flavoring herb . . . . .	.05	.15
SWEET BASIL,—Leaves used for flavoring . . . . .	.05	.15
SWEET FENNEL,—Seeds aromatic . . . . .	.05	.10
SWEET MARJORAM,—Used for seasoning . . . . .	.05	.15
SUMMER SAVORY,—Used for seasoning . . . . .	.05	.15
THYME,—Used for seasoning . . . . .	.05	.45
WORMWOOD,—Used for medicinal purposes . . . . .	.05	.20

"Our Seeds are Northern Grown, None Better at Any Price."

**FLOWER SEEDS**

**STANDARD VARIETIES.**

- |  | Pkt. | Oz. |
|--|------|-----|
| <b>ALYSSUM</b> ,—Sweet, white, very fragrant, annual,  | .05  |     |
| <b>AMARANTHUS</b> ,—"Joseph's Coat,"—Ornamental foliage plant, easily cultivated, very showy, annual, mixed.   | .05  |     |
| <b>ANTIRRHINUM</b> ,—"Snap Dragon,"—Half hardy perennial. An old favorite border plant, blooms the first season, but the flowers are stronger the second year, | .05  |     |



ASTERS

**ASTERS**

One of the most popular and useful of our annuals.

- |  |     |  |
|--|-----|--|
| <b>VICTORIA</b> ,—Finest Mixed,—Flower very large, and double, considered all in all one of the most satisfactory strains of asters, | .10 |  |
| <b>COMET</b> ,—Mixed,—Large beautiful flowers, resembling the Japanese Chrysanthemum,  | .10 |  |
| <b>PERFECTION WHITE</b> ,—Large flowers, one of the best of the white asters,  | .10 |  |
| <b>CHINA</b> ,—Mixed Colors,   | .05 |  |

- |   |     |  |
|---|-----|--|
| <b>BALSAM</b> ,—Mixed Double,—An old favorite summer garden annual, | .05 |  |
|---|-----|--|



CALLIOPSIS

- |   |     |  |
|---|-----|--|
| <b>BACHELOR BUTTON</b> ,—See Centaurea and Globe Amaranth.  |     |  |
| <b>CALLIOPSIS OR COREOPSIS</b> ,—Mixed Colors,—Showy summer bedding annuals, producing a profusion of every shade of yellow, orange crimson, red and brown, | .05 |  |

- |  |     |  |
|--|-----|--|
| <b>CAMPANULA</b> ,—Canterbury Bells.—"Cup and Saucer." The finest variety with white and blue flowers, resembling cup and saucer, hardy perennial, | .05 |  |
|--|-----|--|

- |  |     |  |
|--|-----|--|
| <b>CANARY BIRD VINE</b> ,—Yellow flower, | .05 |  |
|--|-----|--|

- |  |     |     |
|--|-----|-----|
| <b>CANDYTUFT</b> ,—Mixed Annual,—For massing in beds or borders, fine for cutting, | .05 | .20 |
|--|-----|-----|

- |                            |     |     |
|----------------------------|-----|-----|
| <b>CANDYTUFT</b> ,—White,— | .05 | .20 |
|----------------------------|-----|-----|

- |   |  |  |
|---|--|--|
| <b>CARNATION MARGUERITE</b> ,—These beautiful |  |  |
|---|--|--|

flowers are very fragrant, great favorites, comparatively easy to cultivate.

- |                              |     |  |
|------------------------------|-----|--|
| Finest Mixed,                | .10 |  |
| <b>GIANT</b> ,—Finest Mixed, | .25 |  |

- |  |     |  |
|--|-----|--|
| <b>CASTOR OIL PLANT</b> ,—See Ricinus.   |     |  |
| <b>CELOSIA OR COCKSCOMB</b> ,—Glasgow Prize,—Popular annuals of easiest culture, | .10 |  |
| Mixed,   | .05 |  |

- |   |     |  |
|---|-----|--|
| <b>CENTAUREA CYANUS</b> ,—"Bachelor Buttons,"—Mixed, a very old favorite garden annual, | .05 |  |
|---|-----|--|

- |                                       |     |  |
|---------------------------------------|-----|--|
| <b>CLARKIA</b> ,—Hardy Annual,—Mixed, | .05 |  |
|---------------------------------------|-----|--|

- |   |     |  |
|---|-----|--|
| <b>CLEMATIS</b> ,—Hardy Perennial Vine,—Purple, | .10 |  |
|---|-----|--|

- |  |     |  |
|--|-----|--|
| <b>COBAEA SCANDENS</b> ,—Mixed rapid growing climber, flowers large and bell shaped, | .10 |  |
|--|-----|--|

- |   |     |  |
|---|-----|--|
| <b>COLUMBINE</b> ,—A most desirable border plant,—Double mixed, | .05 |  |
|---|-----|--|

- |  |     |     |
|--|-----|-----|
| <b>CONVOLVULUS MAJOR</b> ,—Tall Morning Glory. A rapid free flowering climber, | .05 | .15 |
|--|-----|-----|

- |   |     |     |
|---|-----|-----|
| <b>CONVOLVULUS MINOR</b> ,—Dwarf Morning Glory, | .05 | .25 |
|---|-----|-----|

- |   |     |  |
|---|-----|--|
| <b>COSMOS</b> ,—One of the notable fall flowers,—Giant fancy mixed, | .05 |  |
|---|-----|--|

- |   |     |  |
|---|-----|--|
| <b>CYPRESS VINE</b> ,—Mixed,—Summer climbing annual with feathery foliage and star shaped flowers, borne in clusters, | .05 |  |
|---|-----|--|

- |                              |  |  |
|------------------------------|--|--|
| <b>DIANTHUS, OR PINKS</b> ,— |  |  |
|------------------------------|--|--|

The Dianthus is one of the most beautiful and satisfactory of the garden annuals; they are unrivaled for brilliancy and profusion of bloom.

- |   |  |  |
|---|--|--|
| <b>DIANTHUS CHINENSIS</b> ,—China Pink,—Mixed double, 5c pkt. |  |  |
|---|--|--|



DIANTHUS CHINENSIS

"Our Seeds are Northern Grown, None Better at Any Price."

## FLOWER SEEDS—(Continued)

**DIANTHUS HEDDEWIGII**,—Japan Pink,—Mixed double 10c pkt.

**DOLICHOS**,—Hyacinth Bean,—Mixed annual climbing plant of rapid growth, 5c pkt.

**ESCHSCHOLTZIA**,—"California Poppy,"—Mixed single, very attractive for edgings or masses, large handsome flowers of yellow, orange and white, 5c pkt.

**FORGET-ME-NOT**,—"Myosotis"—Mixed, bears clusters of lovely small flowers, hardy perennial, 10c pkt.

**FOUR O'CLOCK**,—See Marvel of Peru.

**GAILLARDIA**,—Mixed, exceedingly beautiful annuals, blossoms from early summer until frost, unrivalled for cutting, 5c pkt.

**GLOBE AMARANTH**,—Mixed, a species of Bachelor Button, very ornamental, as summer blooming plant, 5c pkt.



DIANTHUS HEDDEWIGII

**HELIOTROPE**,—Finest mixed,—Deliciously fragrant flowering plant, tender perennial, 10c pkt.

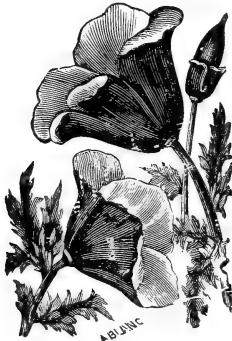

ESCHSCHOLTZIA

**HOLLYHOCK**,—Double mixed,—choice, 10c pkt.

**HYACINTH BEAN**,—See Dolichos.

**LARKSPUR**,—Double dwarf rocket, mixed,—Free flowering hardy annuals, flowers borne in long spikes, 5c pkt.

**LOBELIA**,—Erinus, mixed, a trailing plant, producing bright blue, white or rose flowers, 5c pkt.

**LOVE-IN-A-MIST**,—"Nigella,"—Dwarf, double, foliage feathery, with white or blue flowers, pretty annuals, 5c pkt.

**MARIGOLD**,—Double African mixed,—Very effective for groups and masses; a favorite annual, 5c pkt.

**MARIGOLD**,—Double French Dwarf,—Mixed, 5c pkt.

**MARVEL OF PERU**,—"Four O-Clock,"—Mixed, beautiful summer blooming annual of bushy habit, large flowers of white yellow, crimson and striped, 5c pkt.

**MIGNONETTE**,—Large, flowering, the common sweet mignonette, very fragrant. 5c pkt., 20c oz.

**MIGNONETTE MACHET**,—The Dwarf French variety, with broad spikes of fragrant red flowers, one of the best varieties for out door culture, 10c pkt., 50c oz.

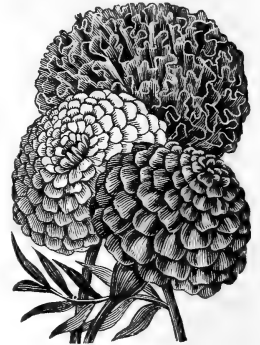

DOUBLE AFRICAN MARIGOLD

**MIGNONETTE**,—"Birds Mammoth,"—The largest variety grown, spikes very full and fragrant, 10c pkt.

**MIGNONETTE**,—Defiance,—Produces mammoth spikes, deliciously fragrant, one of the best for indoor culture, 10c pkt., 50c oz.

**MYOSOTIS**,—See Forget-me-not.

**JAPANESE IMPERIAL MORNING GLORY**—Mixed, strong, rapid climber, producing mammoth flowers; great variety of coloring, 5c pkt.

**MORNING GLORY**,—See Convolvulus.



MIGNONETTE MACHET

"Our Seeds are Northern Grown, None Better at Any Price."

## FLOWER SEEDS.....(Continued)

**NASTURTIUM**,—Tall, fine mixed, beautiful and luxuriant climber, of easiest culture, flowering until frost comes, 5c pkt., 10c oz., 25c  $\frac{1}{4}$  lb., 75c lb.

**NASTURTIUM**,—Dwarf, very popular and showy for masses and border, 5c pkt., 10c oz., 35c  $\frac{1}{4}$  lb., \$1.00 lb.

**NICOTIANA**,—Affinis,—Very fragrant, 5c pkt.

**PETUNIA**,—Single large flowering, mixed, many beautiful colors and combinations, 5c pkt.

**PETUNIA**,—Double large flowering, mixed, a magnificent strain, very beautiful shades, 25c pkt.

## PANSIES

**HOWARD & MORROW'S EXTRA LARGE FLOWERED CHOICE MIXED PANSIES**,—This is a very choice strain of Pansy seed, and under proper cultivation produces mammoth flowers of the most beautiful colors, 25c pkt.



HOWARD & MORROW'S EXTRA LARGE FLOWERED CHOICE MIXED PANSIES. Pkt. 25c

**PORTULACA**,—Double, these make perfectly gorgeous masses of color, 10c pkt.

**RICINUS**,—Castor Oil Plant, mixed, rapid growing foliage, annual, palm leaves, 5c pkt., 15c oz.

**SALPIGLOSSIS**,—Large flowering mixed, a beautiful flowering annual, bearing large flowers of many pretty colors, 5c pkt.

**SALVIA SPLENDENS**,—Bonfire,—Perennial, but blooms the first season, bright scarlet, fine for bedding, 10c pkt.

**SCABIOSA**,—Mourning Bride, Showy border plant. Dwarf, double mixed, 5c pkt.

**STOCKS**,—Dwarf Ten weeks, mixed, highly fragrant, very pretty and a deservedly popular annual, 10c pkt.

**SUNFLOWER**,—Double Dwarf, 5c pkt.

**SUNFLOWER**,—Mammoth Russian, 5c pkt., 10c quart.

**ENGLISH FINEST MIXED**,—10c pkt.

**GOOD MIXED**,—5c pkt.

**PHLOX**,—Drummondii grandiflora mixed for beds and massing nothing can surpass these beautiful annuals, 5c pkt.

**PHLOX**,—Dwarf or nana compacta, mixed, these form little round compact bushes about six inches high, thickly studded with flowers, 10c pkt.

**PINKS**,—See Dianthus and Carnation.

**POPPIES**,—Single mixed, great variety of colors, very showy, 5c pkt.

**POPPIES**,—California—See Eschscholtzia.

**POPPIES**,—Mixed, carnation flowered, 5c pkt.

**POPPIES**,—Iceland Mixed,—10c pkt.

**POPPIES**,—Shirley Mixed,—Extra Fine strain, 5c pkt.

**PORTULACA**,—Single mixed, brilliant dwarf annuals, 6 in. high, for low beds and masses of color they are indispensable, 5c pkt.



PHLOX-DRUMMONDII



## FLOWER SEEDS—(Con.)

### SWEET PEAS

Our stock of this popular flower is very choice. We have revised the list, and it is the selection of the very latest and best.

	Pkt.	Oz.	¼Lb.	Lb.
<b>AMERICA</b> ,—White striped, crimson scarlet,	.05	.10	.20	.50
<b>BLANCHE BURPEE</b> ,—Superb, pure white,	.05	.10	.20	.50
<b>BLANCHE FERRY</b> ,—Pink and white wings,	.05	.10	.20	.50
<b>BLANCHE FERRY</b> ,—Extra early, 10 days earlier than any other sweet pea,	.05	.10	.20	.50
<b>COUNTESS OF RADNOR</b> ,—Delicate lavender,	.05	.10	.20	.50
<b>DOROTHY ECKFORD</b> ,—Pure white, beautiful large flowers,	.05	.10	.20	.50
<b>DOROTHY TENNANT</b> ,—Rose purple. Large fine form,	.05	.10	.20	.50
<b>DUKE OF CLARENCE</b> ,—Rosy claret,	.05	.10	.20	.50
<b>DUKE OF WESTMINSTER</b> ,—Clear purple, tinted violet,	.05	.10	.20	.50
<b>DUKE OF YORK</b> ,—Standards rose scarlet, wings light primrose,	.05	.10	.20	.50
<b>EMILY HENDERSON</b> ,—Pure white,	.05	.10	.20	.50
<b>FIRE-FLY</b> ,—Intense glowing crimson scarlet, large flower,	.05	.10	.20	.50
<b>GLADYS UNWIN</b> ,—Pale rosy pink, superb,	.05	.10	.20	.60
<b>GORGEOUS</b> ,—Standards scarlet orange, wings bright rose tinged orange,	.05	.10	.20	.50
<b>HENRY ECKFORD</b> ,—salmon, orange, large, handsome,	.05	.10	.20	.60
<b>KING EDWARD VII</b> ,—Bright crimson, splendid,	.05	.10	.20	.60
<b>LADY GRISEL HAMILTON</b> ,—Standards Mauve, wings lavender,	.05	.10	.20	.60
<b>LADY MARY CURRIE</b> ,—Standards crimson orange, wings crimson with tint of orange	.05	.10	.20	.50
<b>LOTTIE ECKFORD</b> ,—White edged with blue,	.05	.10	.20	.50
<b>LOVELY</b> ,—Deep pink shading to light pink at edges,	.05	.10	.20	.50
<b>MRS. DUGDALE</b> ,—Beautiful deep rose, fine,	.05	.10	.20	.50
<b>NAVY BLUE</b> ,—Deep indigo blue.	.05	.10	.20	.60
<b>OTHELLO</b> ,—Glossy maroon, elegant,	.05	.10	.20	.50
<b>PRIMA DONNA</b> ,—Pure Pink, best pink,	.05	.10	.25	.60
<b>PRIMROSE</b> ,—Light straw color,	.05	.10	.20	.50
<b>PRIMROSE SPENCER</b> ,—Pronounced primrose,	.05	.15	.35	1.00
<b>QUEEN ALEXANDRA</b> ,—Bright scarlet, red, almost true scarlet,	.05	.10	.20	.60
<b>QUEEN VICTORIA</b> ,—Light primrose,	.05	.10	.20	.50
<b>SALOPIAN</b> ,—Splendid brilliant scarlet,	.05	.10	.20	.50
<b>SENATOR</b> ,—Shaded and striped chocolate on creamy ground,	.05	.10	.20	.50
<b>STELLA MORSE</b> ,—Primrose, flushed pink, beautiful,	.05	.10	.20	.50
<b>HOWARD &amp; MORROW'S CHOICE SPECIAL MIXTURE</b> of named varieties,	.05	.10	.25	.40 .75
<b>MIXED COLORS</b> ,—Fine Mixture,	.05	.10	.20	.30 .40
<b>SWEET WILLIAM</b> ,—Single mixed, an old favorite, rich variety of color, deliciously sweet scented, 5c pkt.				
<b>VERBENA</b> ,—Finest, mixed, for garden beds or massing, the verbena is unrivaled; flowers from spring until late in autumn, 10c pkt.				
<b>WALLFLOWER</b> ,—Double large flowering mixed, exquisitely fragrant, long spikes of double flowers, hardy perennial, 10c pkt.				
<b>WILD FLOWER GARDEN</b> ,—A mixture of popular annuals, very pleasing for children's flower bed, 5c pkt.				
<b>ZINNIA</b> ,—Double mixed, very showy, free flowering, hardy annual, 5c pkt.				



**BIRD SEEDS**

CHOICE MIXED, per lb.	10c, 3 lbs. 25c	MILLET,—per lb.	10c, 3 lbs. 25c
CANARY,—Choice Sicily,	10c, 3 lbs. 25c	RAPE,—	per lb. 10c, 3 lbs. 25
HEMP,—	- - - -10c, 3 lbs. 25c	SUNFLOWER,—	See Flower Seeds.

**VEGETABLE ROOTS**

ARTICHOKE JERUSALEM,	25c qt., \$1.25 pk.
ASPARAGUS ROOTS,—	See page 2.
CHIVES,	25c per bunch
HORSE RADISH ROOTS,	20c per doz., 75c per 100
TARRAGON PLANTS,	35c each, \$3.50 per doz.
GARLIC SETS,	35c per lb.

**List of GRASSES and CLOVER Adapted to this Climate**

PRICES SUBJECT TO MARKET CHANGES.

	Weight Per Bushel.		Weight Per Bushel.
CREEPING BENT GRASS,—Excellent for lawns, succeeds well in most situations,	20 lbs.	SWEET VERNAL TRUE PERENNIAL,—Emits an agreeable odor, which it imparts to the hay,	10 lbs.
ENGLISH RYE GRASS,—A valuable grass,	24 lbs.	TALL MEADOW FESCUE,—Very early, nutritive and productive. Should form a portion of all pastures on wet or clay soils,	14 lbs.
FOWL MEADOW GRASS,—Uncleaned seed,	12 lbs.	TALL MEADOW OAT GRASS,—Recommended for soiling, being rapid and luxuriant in its growth,	10 lbs.
HARD FESCUE,—A dwarf growing grass of great value, succeeding well in dry situations,	12 lbs.	TIMOTHY OR HERD GRASS,—We offer a particularly "choice sample,"	45 lbs.
HUNGARIAN GRASS,—Is a valuable annual forage plant, 1 bushel to the acre,	48 lbs.	VARIOUS LEAVED FESCUE,—Valuable for permanent pastures, especially on high altitudes,	14 lbs.
ITALIAN RYE GRASS,—Thrives in almost any soil and yields early and abundant crops,	18 lbs.	WOOD MEADOW GRASS,—Of early growth, thriving well under trees,	14 lbs.
KENTUCKY BLUE GRASS,—Fancy,	14 lbs.	ALFALFA OR LUCERNE,—In light soils, particularly in southern altitudes, it is invaluable,	60 lbs.
MEADOW FESCUE,—Of great value in mixtures for permanent pastures,	22 lbs.	ALSIKE OR HYBRID CLOVER,—Equal in nutritive value to the Red or Pea Vine Clover, and excellent for land that is cloversick,	60 lbs.
MEADOW FOXTAIL,—Is the principal grass in all rich, natural pastures,	7 lbs.	MAMMOTH RED OR PEA VINE CLOVER,—	60 lbs.
ORCHARD GRASS,—One of the most valuable grasses either for pasture or hay,	14 lbs.	RED CLOVER MEDIUM,—	60 lbs.
RED TOP GRASS,—Choice,	14 lbs.	SCARLET CLOVER,—Sow in July or August for mowing the ensuing spring,	60 lbs.
Fancy or extra re-cleaned seed,	32 lbs.	WHITE CLOVER,—Should be used in all mixtures for permanent pasture and for lawns,	60 lbs.
RHODE ISLAND BENT GRASS,—A very fine variety for lawns,	14 lbs.		
ROUGH STALKED MEADOW GRASS,—Valuable for pastures and meadows, particularly on damp soil,	14 lbs.		
SHEEP'S FESCUE,—Short and dense in growth, excellent for sheep pastures,	12 lbs.		

OUR SPECIAL GRASS MIXTURE FOR PASTURES,—Usual quantity sown to the acre, 3 bushels. Per bushel of 14 lbs. \$2.50. 10 bushel lots \$2.35 per bushel.

We recommend sowing separately from this, 10 lbs. mixed clover per acre.

OUR SPECIAL GRASS MIXTURE FOR HAY,—On ordinary soils use 3 bushels per acre. In ordering state whether soil is dry, medium or wet. Per bushel of 14 lbs. \$2.50, 10 bushel lots, \$2.35 per bushel.

“Our Seeds are Northern Grown, None Better at Any Price.”

## GRAINS—Prices according to Market

- BARLEY**,—2 or 4 rowed, Choice Montana, price variable, per bushel 48 lbs. \$2.00.  
**BARLEY**,—York State—Fancy, Market price.  
**BARLEY**,—New White Hullless—2 weeks earlier than common, \$2.45.  
**BUCKWHEAT**,—Silver Hull,—48 lbs. per bushel. **Japanese**, 48 lbs. per bushel.  
**OATS**,—Choice White, 32 lbs. per bushel.  
**OATS**,—White Swedish,—These oats give excellent satisfaction, straw is strong, not apt to lodge, per bushel 32 lbs., \$1.40.  
**OATS**—Big Four,—Heavy yielders, stiff straw, per bushel \$1.25.  
**RYE**,—Spring,—For sowing in the spring, 56 lbs. per bushel.  
**RYE**,—Winter,—For fall sowing, 56 lbs. per bushel.  
**WHEAT**,—Spring,—60 lbs., per bushel. **Winter**, 60 lbs. per bushel.  
**HUNGARIAN GRASS**,—One of the most valuable soiling plants, excellent for green fodder or hay, yields enormously; sow from June to August, 48 lbs. per bushel. Market price.  
**MILLET**,—German or Golden,—Similar to above, flower stem more branching. 50 lbs. per bushel. Market price.  
**MILLET**,—Japan,—Barnyard (Crus-galli). A new variety, exceedingly heavy yielder, requires very rich soil. Per lb. 10c., per 10 lbs. 90c., per 100 lbs. \$8.00.  
**FLAX**,—Extra re-cleaned, per lb. 10c, 3 lbs. for 25c.  
 Special prices on larger quantities.

## LAWN GRASS SEED

**OUR LAWN GRASS SEED** is a specially reliable mixture of fine growing grasses, entirely free from weed seeds and can be depended on to produce a perfect, velvety green turf if properly sown and cared for. Quantity required per acre, 4 bushels. Price per quart 15c, peck \$1.00, bushel \$4.00.

### POINTS WORTH REMEMBERING IN MAKING A LAWN.

At least six inches of the surface soil should be alike and even, for nothing looks worse than to see a lawn grown in patches. So many noxious weeds are introduced into the ground with barnyard manure that its use is not recommended. The ground should be well prepared and rolled previous to sowing, it should then be gone over with a fine rake, the seed then evenly scattered over the surface at the rate of four bushels per acre. The whole should then be raked or bushed in and again rolled. When the grass has attained a height of three inches it should be cut with a sharp scythe; never use a lawn mower that “pinches off” or “pulls” the grass, it should “clip” it with a good shear cut. Frequent mowings and rollings are necessary to keep a lawn in good condition. Once or twice during the season an application of Mapes or Quinnipiac should be applied as a top dressing. To “thicken up” the grass use one bushel lawn seed per acre. Don't forget the roller. Use a good Lawn Mower, in good cutting order.

### REPAIRING LAWN MOWERS

We repair and sharpen Lawn Mowers of all kinds, putting them in first-class working order. Should any be sent to us that are too nearly worn out to repair, we will so advise.

### LAWN AND GARDEN ROLLER

Two Sections, each 12x24 inches, weight about 450 lbs., \$17.50.



“Our Seeds are Northern Grown, None Better at Any Price.”

**HORSE LAWN ROLLERS**



Very strong, wood work of heavy oak, can be loaded to any desired weight. Nine sizes are made of which the 3 section and 4 section rollers are rigged with shafts for one horse, other sizes have pole for two horses unless otherwise ordered.

Description.						Weight.	List Prices.	
3 Sections, each 12 in. long by 20 in. diam.,						575 lbs.	\$35.00	
4 “ “ 12 “ 20 “						750 “	42.50	
5 “ “ 12 “ 20 “						950 “	50.00	
4 “ “ 12 “ 24 “						850 “	50.00	
5 “ “ 12 “ 24 “						1050 “	57.50	
6 “ “ 12 “ 24 “						1250 “	65.00	
4 “ “ 12 “ 30 “						1175 “	60.00	
5 “ “ 12 “ 30 “						1450 “	72.50	
6 “ “ 12 “ 30 “						1700 “	85.00	
Seat with Spring—Extra,								2.50

**BERKSHIRE GARDEN BARROW**

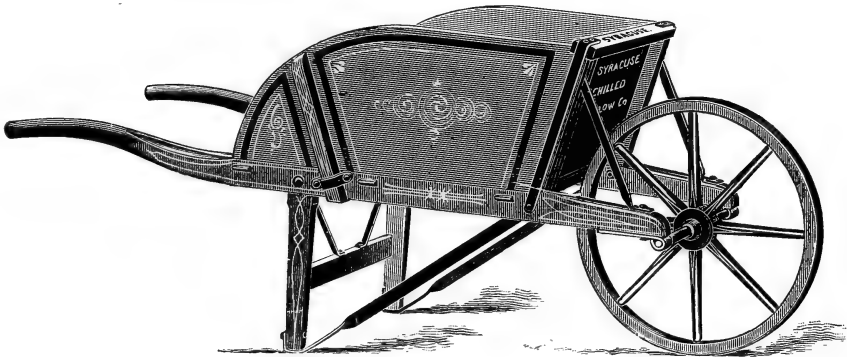

A strong, well made Garden Barrow, nicely painted.

	PRICE.
No. 2, Boys, . . . . .	\$3.50
No. 4, Common Size, . . . . .	4.00
No. 6, Large Size, . . . . .	4.75

**OUR CUSTOM GARDEN BARROW**

Very strong, heavily ironed—and the best barrow we know of.

No. 4, Medium, . . . . .	\$5.00
No. 5, Large, . . . . .	6.00
No. 6, Extra Large, . . . . .	7.00



## SYRACUSE No. 60 SWIVEL PLOW

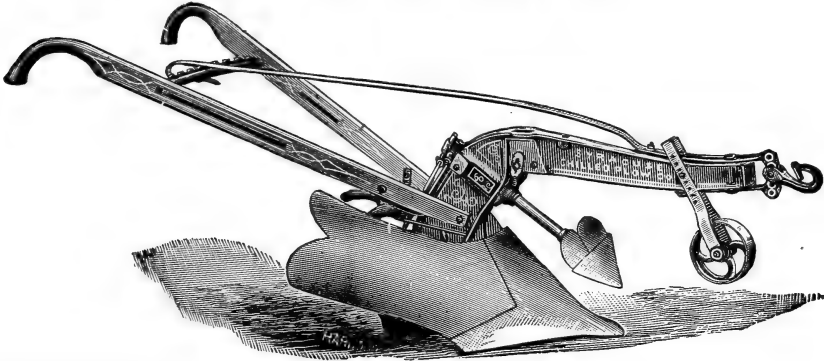

AN EXCELLENT WORKING PLOW.  
WELL MADE, STRONG AND RELIABLE.

Price Complete, \$15.00

## SYRACUSE STEEL BEAM LANDSIDE PLOW

No. 31 with steel mouldboard,—a splendid plow. If you have difficult land to turn, this will do it when other plows fail.

Price Complete, \$17.00

## 4-S ROUGH AND READY LANDSIDE PLOW

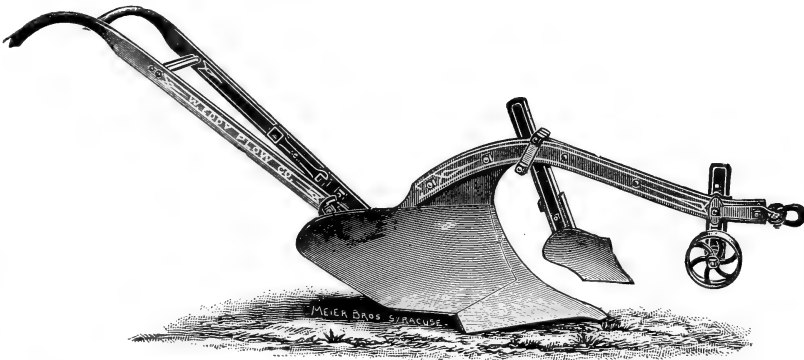

A strong, good working plow, not heavy, with wrought steel beam.  
Price Plain, \$11. Price, with Wheel, \$12. Price, with Wheel and Jointer, \$14.

We recommend using the Wheel and Jointer for perfect work.  
Rough and Ready, No. 36-S Swivel Plow. Complete with Wheel and Jointer and with wrought steel beam, \$17.50.

## HILLSDALE LANDSIDE PLOW

A very good Low Priced, Two-Horse Plow, Cast Beam.

PRICE, PLAIN \$7.00.

PRICE, WITH WHEEL, \$7.50.

"Our Seeds are Northern Grown, None Better at Any Price."

## COLUMBIA CHILLED PLOW, No. 3

This is a genuine favorite with the farmer. It is very strong, light draft, easy to handle, and does the work to perfection. Price Complete with Wheel and Jointer, \$10.00.

## THE ARMSBY LANDSIDE PLOW

Wood Beam and Cast Mouldboards. For light work we recommend this plow.  
No. 1, Small One-Horse, \$4.50. No. 2, Medium One-Horse, \$5.50. No. 3, Large, \$6.50.

## SUBSOIL PLOW,

The Subsoil Plow follows in the furrow of the plow, turning the surface soil.  
No. 1, Two-Horse, with draft rod, \$9.50; with draft rod and wheel, \$11.00.

## CONTRACTOR'S PLOW, No. 1

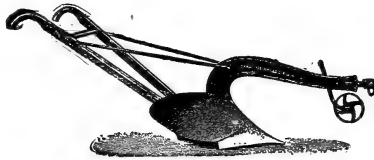

Heavy beam, point and strip. Made especially for grading purposes. Weight 200 lbs.  
Two or four horses. Price, with wheel, \$15.00.

## PAVEMENT PLOW, No. 98



A favorite with contractors. Has reversible crucible steel point, loop handle wear irons, built for hard work, such as tearing up cobblestones and Macadam.  
Four or six horses. Weight 280 lbs., \$25.00.

## TRUSS BEAM GRADING PLOW, No. 99



For severe grading purposes in shale or hard pan. Four or eight horses.  
Weight 310 lbs., \$35.00.

## Plow Repairs

WE CARRY A LARGE STOCK OF PLOW REPAIRS AND CAN FURNISH PARTS FOR ALMOST ANY PLOW EVER MADE

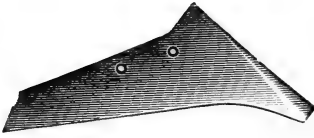

### SUCCESS MANURE SPREADER

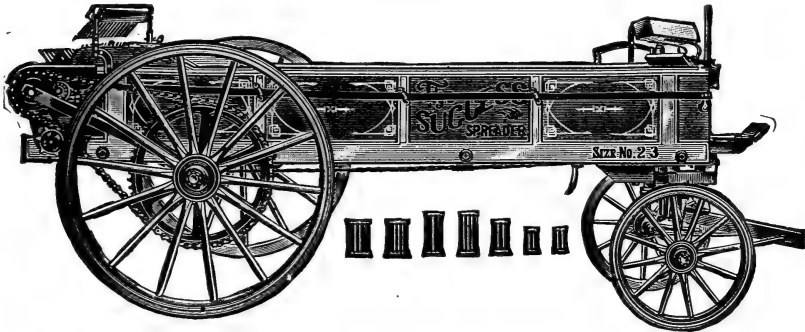

Marked changes and improvements have been made in these labor saving machines in the past few years. They are made in three sizes—the 50 bushel being the common size. Prices on application.

### THE YANKEE DISC HARROW

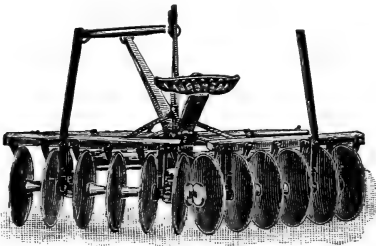

REGULAR DISC.

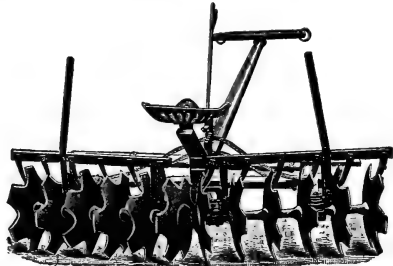

SHEAR CUT DISCS.

An excellent harrow, made to supply the demand for a little lighter harrow, yet capable of doing a vast amount of good work. Price Complete, with 16 in. discs, \$28.00. Price Complete, with 18 in. discs, \$31.00. Price shear cut discs \$2.00 extra.

### SYRACUSE DISC HARROW

Strong and well made. As light draft as any disc harrow doing the same amount of work. Price, with two levers, including Whiffletrees, Evener, and Neckyoke, \$29.00.

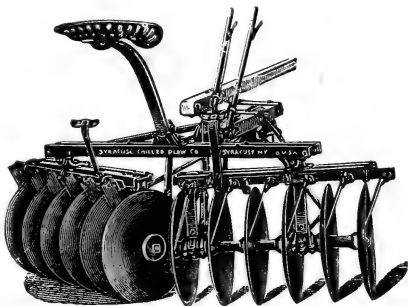

THE ADRIANCE DISC HARROW,—One of the best disc harrows made. Price with 16 inch discs complete \$28.00.

## STEEL FRAME SMOOTHING HARROW

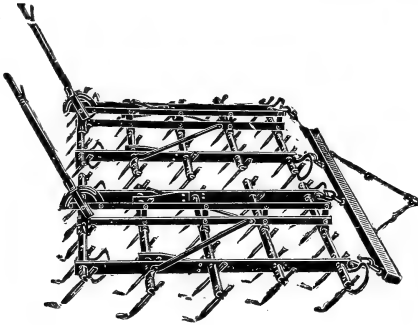

Can be instantly  
Changed from a  
Smoothing to  
a Regular Spike  
Tooth Harrow

This is one of the VERY BEST STEEL SMOOTHING HARROWS made. Lever adjustment, strong and well made.

Price—2 Sections, 50 teeth, \$17.00.

Price—3 Sections, 75 teeth, \$22.00.

## CLARK'S CUTAWAY HARROW

Clark's Cutaway Harrows are well known and hardly need description here, they are made in Double Action, that is double sets of gangs, (see cut). Regular Double Lever Cutaway, and Double Lever Solid Disc, and in many sizes, the sizes most suitable for this section are:—

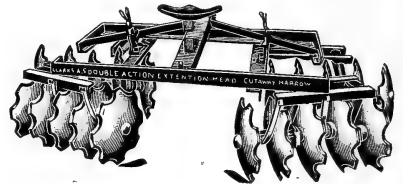

Double Action, 16 in. Disc,	\$32.10	With extension head, \$34.60.
Double Lever Cutaway,	23.00	
Double Lever Solid Disc,	22.00	

## SPRING TOOTH HARROWS

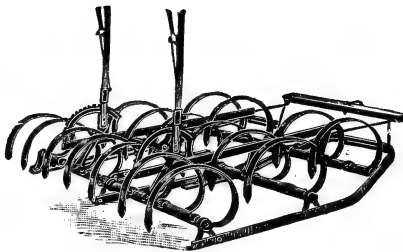

The Osborne was the first Lever Spring Tooth Harrow placed on the market and it stands well in the front rank today.

Price, 9 Tooth, One Horse,	\$10.00
" 15 Tooth,	17.00
" 17 Tooth,	18.00
" 16 Tooth, Combination Harrow and Leveler,	18.00

## THE OTSEGO LEVER SPRING TOOTH HARROW

This is one of the best of the Spring Tooth Harrows.

Price, 15 tooth, complete, \$15.00.

17 tooth, complete, \$10.09.



# LEADER LAND ROLLER

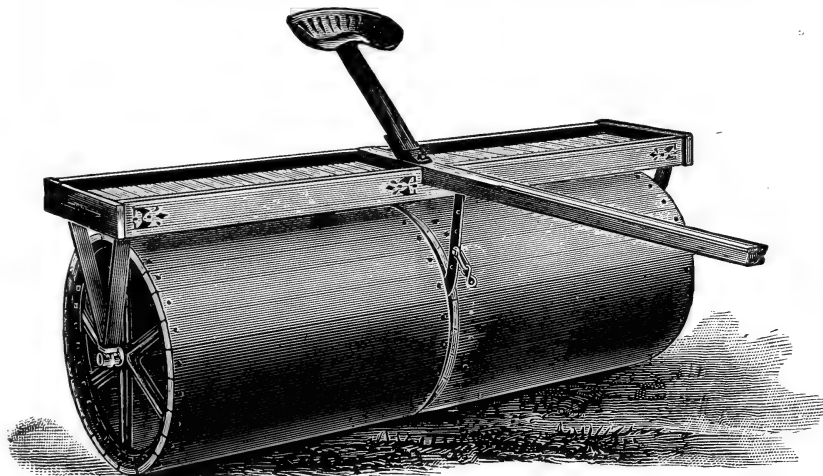

It is 8 feet long, about 30 inches in diameter, perfectly balanced, no weight on horses' necks. The staves are 2-inch white oak.

PRICE - - - - \$22.00

## SPECIAL WOOD STAVE LAND ROLLER

Length 8 ft., diam. 39 in., - \$40.00

## STEEL FIELD ROLLER

The drum of this roller is steel instead of wood; it is 24 inches in diameter, has removable dust-proof boxes, and it is a good one.

Price—3 Section, 7 ft., - \$32.00

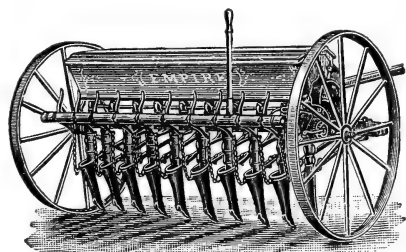

## THE EMPIRE GRAIN AND FERTILIZER DRILL

This Drill sows Grain, Grass Seed and Fertilizer perfectly. It has a positive force feed, will not break the grain, is light draft, is not complicated, evenly balanced, rests lightly on the horses' necks and is fully warranted.

Price of 10 Tube Drill, - \$86.00

## THOMPSON'S WHEELBARROW GRASS SEEDER

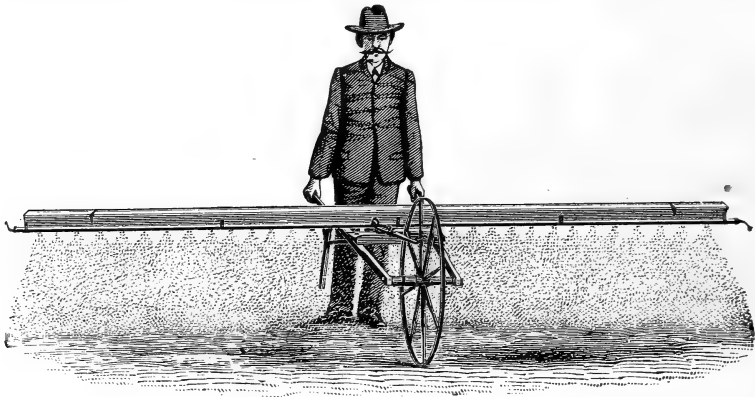

It sows any kind of Grass Seed perfectly and rapidly; width of Seeder Box 12 ft. and 14 ft. Price \$9.00. Seeder for sowing Timothy and Clover only, \$8.00. Extra Seeder Box for Grain only, \$5.00.

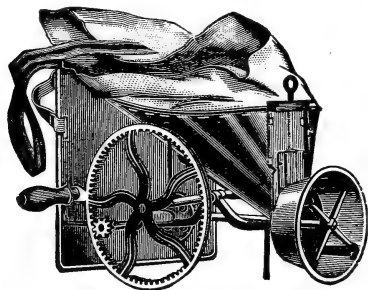

### —CAHOON— BROADCAST SEED SOWER

Sows both Grass Seed and Grain

Price \$4.00

### Eclipse Corn Planter and Fertilizer Distributer

Plants Corn, Beans, Peas, etc., perfectly, and at the same time distributes evenly the fertilizer in such a manner that it does not come in direct contact with the seed.

Price, Single Row Planter, \$25.00  
" Double Row Planter, 50.00

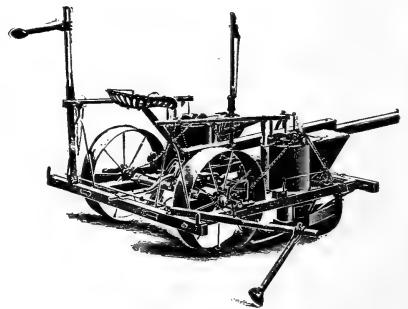

### Star Billings Planter and Fertilizer Distributer

An excellent machine, does its work nicely, and will plant twelve different distances apart, running from 5½ in. to 72 in. Price \$18.00.

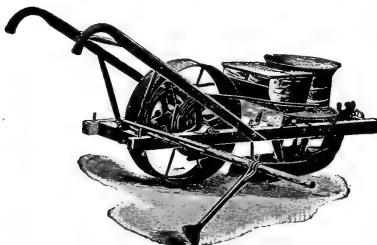

### King of Cornfield Corn Planter and Fertilizer Sower, \$25.00

AN EXCELLENT PLANTER  
VERY SIMPLE IN CONSTRUCTION

Wiard Automatic Hand Corn Planters, \$2.00  
Corn Huskers, 15c and 25c  
Corn Ties,—With four feet of rope, per 100, \$1.25

**STROWBRIDGE IMPROVED**  
**Broadcast Seed and Plaster Sower**

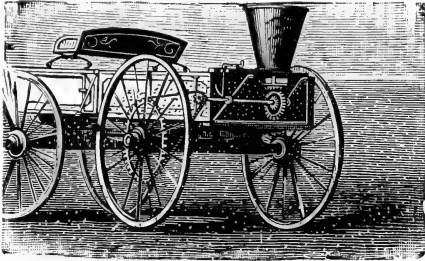

From 50 to 75 acres can be sown with one team in a day.

Oats, Rye, Barley, Buckwheat, Hungarian, Grass, Clover, Timothy, and every variety of Seed and Grain requiring broadcasting can be sown with this machine; also with care, Plaster, Lime, Salt and Fertilizers. It can be attached to any farm wagon.

Price \$10.00

**WOOD BEAM SHOVEL PLOW**

Steel Point and Adjustable Steel Wings,  
 and the price is only,                     \$3.50  
 With Steel Beam,                             \$4.50



**IMPROVED FURROWER AND MARKER**

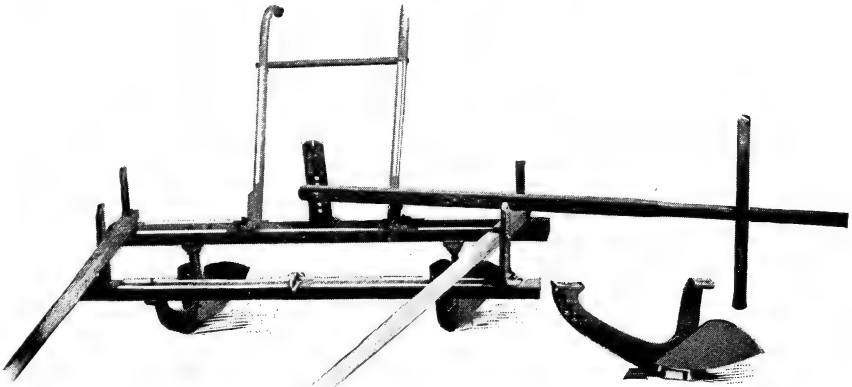

Marks and Furrows at the same time, adjustable to mark any width or depth. The wearing part of the runners are chilled iron, the wings are steel and the frame is oak; it is a labor saver.

Price No. 1, makes 3 furrows at once, \$10.50. Price No. 2, makes 2 furrows at once, \$9.50.

## "PLANET JR." No. 4

Hill and Drill Seeder

Wheel Hoe

Cultivator and Plow

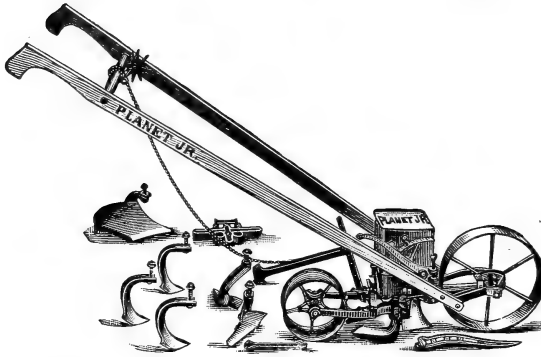

Hopper holds two and one half  
quarts seed.

Price complete - - \$11.00

As a seeder only - - \$9.00

## "PLANET JR." Combined Drill, Wheel Hoe, Cultivator and Plow

A perfect seed sower, and the attachments are capable of making more combinations than we have space to describe, and each one works perfectly.

### PRICE

- No. 1. Combined Machine as  
shown, \$9.50  
No. 2. Plain Drill without at-  
tachments, \$7.50

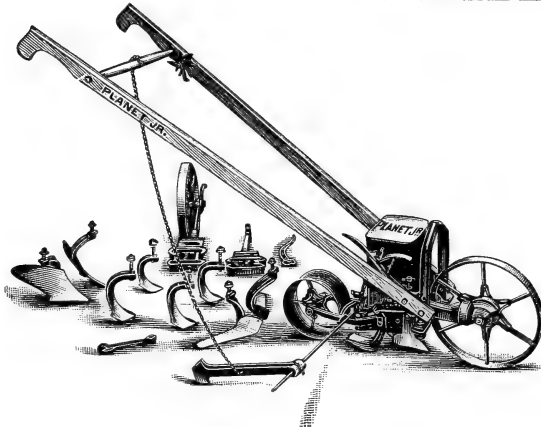
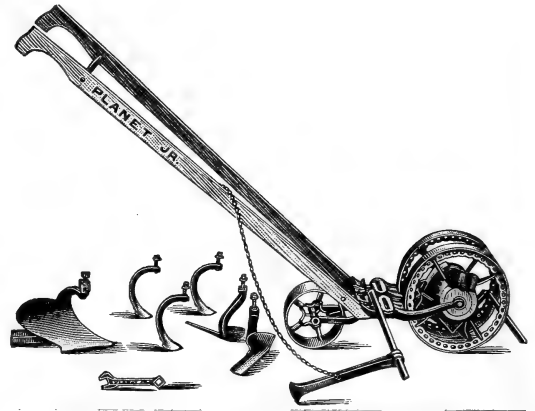

## PLANET JR.

### No. 25

Combined Hill and Drill Seeder, Double Wheel Hoe, Cultivator and Plow. Hopper holds two and one half quarts. Substantial and accurate, two good machines in one. Price \$13.50.

### PLANET JR. No. 17. SINGLE WHEEL HOE.

Consists of one pair 6 in. hoes, three cultivator teeth, one garden plow. Price \$5.00.



## Planet Jr. No. 12

Double Wheel Hoe,  
Cultivator and Plow

PRICE \$7.00

With this machine one man can do more and better work than six with ordinary hoes. Capable of almost an endless variety of changes.

We also sell this with only the long hoes (which are shown attached in cut) and without leaf guards; this we call the Plain Double Wheel Hoe.

No. 13, Price \$4.75

No. 11.—Higher Wheel, more attachments, Complete \$9.00

No. 14.—Double Wheel Disc Hoe, Cultivator and Plow, Complete, \$8.00

## No. 8 "Planet Jr." All Steel Horse Hoe and Cultivator

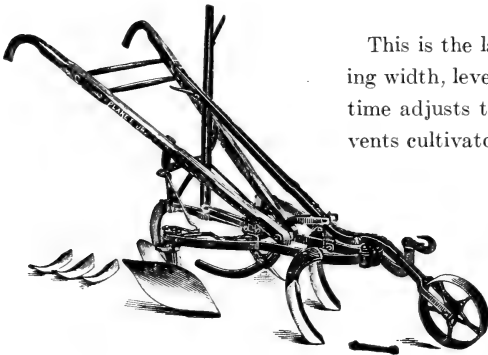

This is the latest in this line. Has lever for adjusting width, lever for adjusting wheel, which at the same time adjusts the NEW DEPTH REGULATOR. This prevents cultivator settling at the back end

Price complete as shown in cut, \$9.00.

NO. 7 "PLANET JR.," HORSE HOE AND CULTIVATOR—Similar to No. 8. Two levers but no depth regulator. PRICE \$8.50.

NO. 9 "PLANET JR.," HORSE HOE AND CULTIVATOR—Same as No. 7 excepting has no wheel lever. PRICE \$7.75.

### "PLANET JR." HARROW and CULTIVATOR

Price, Plain,	\$6.20
" with wheel,	7.40
" complete,	9.00

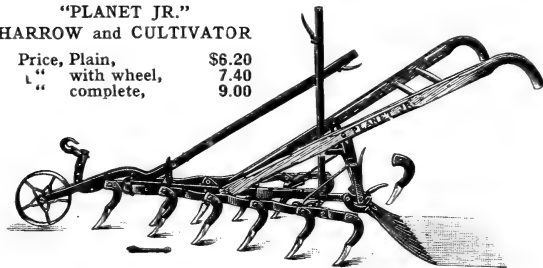

A glance at this cut will convince you that this is a thoroughly practical tool; it is what is called a Harrow, Cultivator and Pulverizer. The handles are adjustable sideways so that you need not walk on the finished work.

## "Farmers'" No. 19 Single Wheel Hoe, Cultivator and Plow

To meet the demand for a good wheel hoe for the kitchen garden at a low price. Six different attachments. Price complete, \$3.75.

## ALL STEEL HORSE HOE AND CULTIVATOR

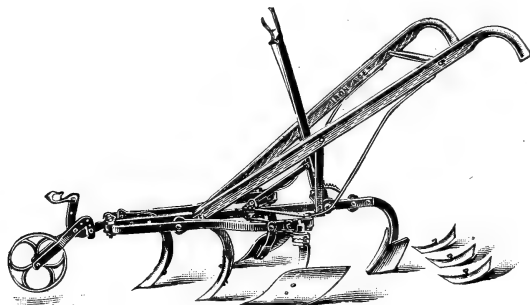

This is a good implement, not our best but a very good one for little money.

(All steel but the handles.)

Price complete with hilling wings, - - - - -	\$6.50
Price without hilling wings, - - - - -	\$4.75
Norcross Hand Garden Cultivator, - - - - -	\$1.00

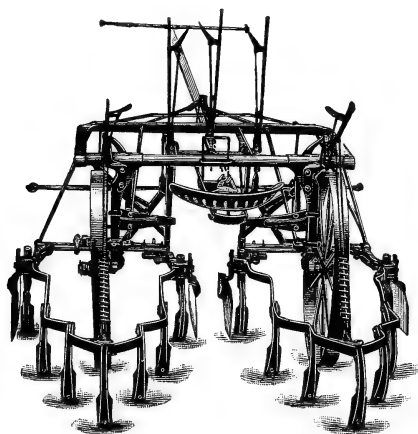

### Planet Jr. No. 72, Two Row Pivot Wheel Cultivator, Plow, Furrower and Ridger, with Spring Trip Standards.

This tool is so designed that the operator can make changes in width of gauge instantly while machine is in motion thereby adjusting it perfectly to rows varying greatly in width. Think of the saving in cultivating perfectly two rows of potatoes, beans, corn, or any crop planted in rows [any widths from 28 inches to 44 inches apart] at a single passage. It is a remarkably good tool.

Price Complete, \$61.25

## WIARD ADJUSTABLE WEEDER

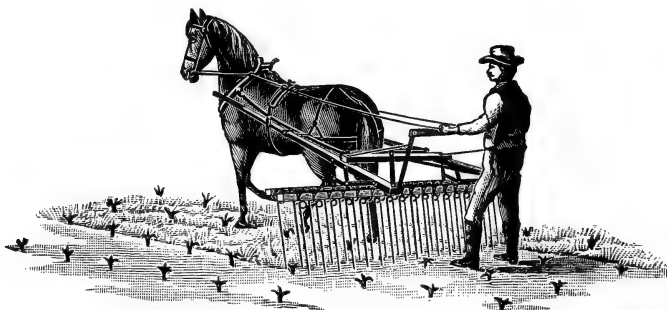

Probably as good weeder as there is made, strong, capable of many adjustments, universally liked if used as intended.

PRICE, \$9.00

## THE IRON AGE (Improved Robbins) POTATO PLANTER

With the IMPROVED ROBBINS the farmer has the comfortable assurance that his Potatoes are being well planted, and the work is being done at the lowest possible cost, easily planting from four to seven acres per day.

PRICE—With Fertilizer distributor, \$80.00  
 Without Fertilizer distributor, 70.00  
 Corn, Bean and Pea attachment, extra, 5.00  
 Leveller attachment, extra, 1.50

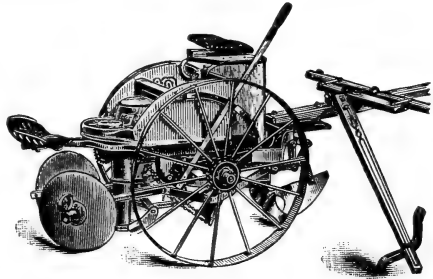

## IRON AGE POTATO DIGGER

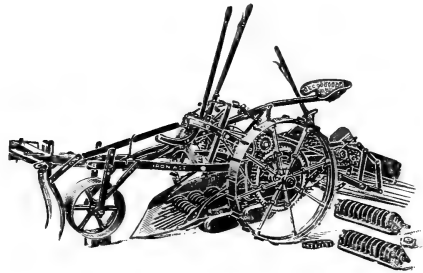

A practical digger, working well in almost all kinds of soil where it is reasonably free from weeds and grass, in fact working well under many unfavorable conditions where other diggers fail.

No. 120 Digger \$90.00  
 Elevator attachment, complete with 3-horse hitch, extra, 15.00  
 Spur attachment for wheels, extra, 3.00  
 Disc attachment, extra, 8.00  
 No. 150 Digger, lighter than No. 120 but very strong, does nice work, 75.00

## Our New Potato Coverer and Hoe

This tool promises to displace all others for ridging and covering potatoes. It is adjustable in many ways, stands high and is especially valuable for hoeing potatoes.

PRICE WITH POLE and wings as shown, \$10.00

PRICE WITH POLE and discs in place of wings 11.00

Use the Quinnipiac and Mapes Fertilizers to raise nice Potatoes.

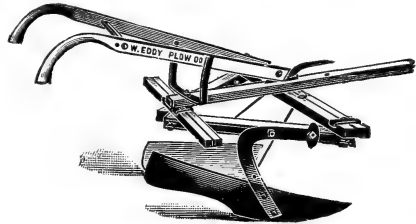

## BASKETS

Vegetable, handles over, No. 1, 18x11x6½ \$ .30  
 " " " No. 2, 20x13x7 .40  
 " " " No. 3, 22x14x7½ .05  
 " " " No. 5, 25x16x9½ .75  
 Picking Drop Bail.....25c and .50  
 Oblong or Stable (cut under handles)... .50  
 " " " " " .75  
 Cheap Diamond Market..... .10 to .20  
 Covered Cheap Diamond Market..... .10 to .35  
 One bushel, Common Stave..... .25  
 " " Smooth Stave..... .50  
 " " Hand made Oak or Ash. 75 & 1.00

1½ bushel Hand made Ash..... 1.50  
 Two " " " " " 1.75  
 One " Metallic, Heavy..... 1.00, 1.25  
 1½ " " " " " 1.50  
 Two " " " " " 1.75  
 Egg Baskets..... .30  
 Rustic Hanging..... \$1.00, 1.25  
 White Wax Paper, for flowers, ream, \$1.50 and \$3.00.  
 White Tissue, ream..... \$1.25 and \$2.50  
 Manila Tissue, ream..... 2.00

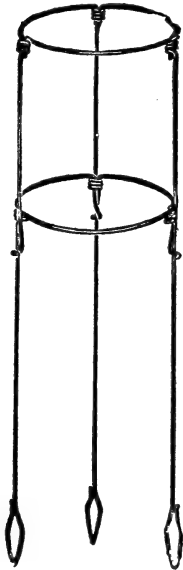

BAMBOO CANES,—6 ft. long, \$1.00 per 100; 8 ft. long \$1.50 per 100.

STAKES, SQUARE, GREEN, TAPERING,—

	EACH.	DOZ.	HUNDRED.
2 feet	3c.	30c.	\$1.75
3 "	5c.	55c.	3.50
4 "	7c.	75c.	5.00
5 "	9c.	\$1.00.	7.00
6 "	11c.	1.25.	8.50

STAKES, ROUND, GREEN, TAPERING,—

	EACH.	DOZ.	HUNDRED.
2 feet	3c.	35c.	\$2.00
3 "	6c.	60c.	4.00
4 "	8c.	85c.	5.50

STAKES OR DAHLIA POLES, HEAVY ROUND,—

	EACH.	DOZ.	HUNDRED.
5 feet	12c.	\$1.40.	\$ 9.00
6 "	17c.	1.75.	11.00

GALVANIZED WIRE STAKES,—

	EACH.	DOZ.	HUNDRED.
3 feet		35c.	\$2.00
3 1/2 "		40c.	2.25
4 "		45c.	2.50
5 "		50c.	3.00
6 "		60c.	3.50

WOOD GARDEN LABELS,—(100 in. pkg.)—

	PLAIN.	PAINTED.
8 inch, per hundred	40c.	50c.
12 "	55c.	65c.

WOOD POT LABELS,—(1000 in. pkg.)—

	PLAIN.	PAINTED.
4 inch	60c.	90c.
6 "	\$1.00.	\$1.35

FLOWERS STEMS—(Wired Tooth Picks), per box of 10000, \$1.75.

CARNATION SUPPORT.—"Model Extension," 2 ring, per doz. 50c; per 100, \$3.00; 3 ring, per doz., 60c; per 100, \$5.00.



- GARDEN REELS large.....75c
- " " extra large.....1.00
- GARDEN LINES, (100 ft.).....50c
- GARDEN TROWEL, (common) 10c
- " " solid steel 40c
- " " forged steel 60c
- " " transplanting 25 and 50c

WEEDING FORK.....15c

FLORAL SETS

- 3 in set (small).....10c, 25c, 50c
- 4 in set, strong (large) .75c, 1.00, 1.25
- FRUIT PICKERS (wire).....25c
- GLASS CUTTER.....25c and 35c

ENGLISH SCUFFLE HOES.

- 5 inch.....55c
- 6 ".....60c
- 7 ".....65c
- 8 ".....70c
- 9 ".....75c
- 10 ".....85c
- Handles extra.....20c
- COMMON SCUFFLE.....60c
- ASPARAGUS KNIVES.....55c

THERMOMETERS

- Tested. 12 inch, metal case.....\$1.00
- Common. 12 " " " "......30
- " 10 " " " " "......25
- " 8 " " " " "......20
- " 6 " " " " "......15

Hot Bed, guaranteed, \$2.00; not guaranteed, 1.25  
Self registering.....\$1.25 to \$3.00

FULL LINE FANCY THERMOMETERS.

HAND WEEDERS

10c to 20c

TOMATO SUPPORT

Price 20c Each—Per Doz., \$2.00



Tree  
Tubs

Cedar

Green  
Outside

Brown  
Inside

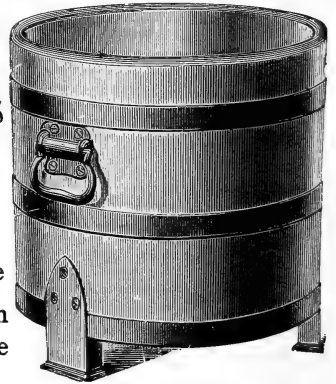

NO.	OUTSIDE DIAM.	LENGTH	STAVE.	PRICE.
0	27 inch	24 inch		\$6.00
1	25 "	22 "		5.00
2	23 "	20 "		4.50
3	21 "	18 "		4.00
4	18 "	16 "		3.50
5	16 "	14 "		2.75
6	14 "	12 "		2.35
7	13 "	11 "		2.00
8	12 "	10 "		1.75

NEW YORK TREE TUBS

Made of Virginia White Cedar, painted green.

No.	Diam.	Height	Each
No. 1	12 inches	10 <sup>5</sup> / <sub>8</sub>	\$1.15
" 2	13 "	12 <sup>3</sup> / <sub>4</sub>	1.50
" 3	14 <sup>1</sup> / <sub>2</sub> "	14 <sup>3</sup> / <sub>4</sub>	1.85
" 3 1/2	16 <sup>1</sup> / <sub>2</sub> "	15 <sup>3</sup> / <sub>4</sub>	2.45
" 4	19 <sup>1</sup> / <sub>2</sub> "	16 <sup>5</sup> / <sub>8</sub>	2.65
" 5	22 <sup>1</sup> / <sub>2</sub> "	18 <sup>1</sup> / <sub>2</sub>	3.45



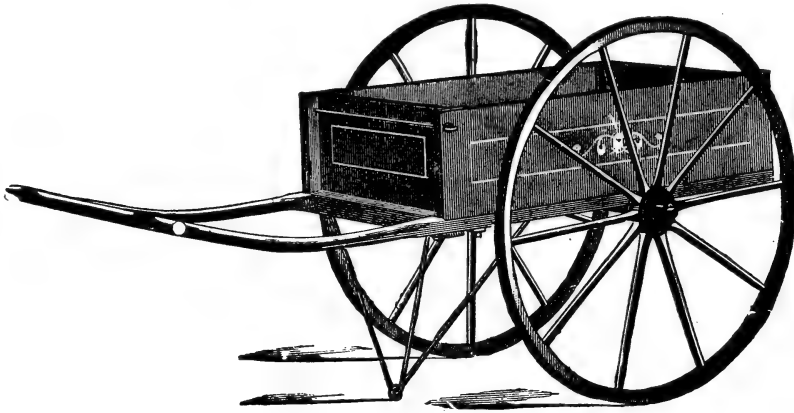

**PUSH CART.**—Well made, a practical, serviceable Cart.

Size of Box.	Wheels.	Axle.	Weight.	Price.
No. 338—A—32x20x 9 in.	30x1 in.	3/4 in.	68 lbs.	\$10.50
No. 338—B—40x23x10 in.	36x1 in.	3/4 in.	82 lbs.	11.00
No. 338—C—48x28x10 in.	42x1 in.	3/4 in.	92 lbs.	11.50

Furnished with Springs. \$2.00 additional.

**SPECIAL LAWN CART.**—With Leaf Rack,

\$20.00

**Iron Cut Flower Vases for Cemetery**

- "Tulip Pattern," 25c to 50c
- "Calla Pattern," 25c to 50c
- Tin.....10c



**HOT-BED MATS.**

Made of Jute, thickly padded, 76x76 in. Price each \$1.50 to \$1.80.

- Improved Mole Trap, \$1.50
- Pruning Shears, 7 in. light Steel..... 45c

- Pruning Shears, 8 in. steel..... 65
- " " 8 1/2 in. steel..... 75
- " " 8 in. Malleable steel blades..... 50
- " " French..... \$1.00 and \$1.25
- Flower Picking Shears (nickled) \$1.00 and \$1.50
- Grape Thinning Shears..... \$1.00 and 1.25, 1.50
- Grass or Sheep Shears..... 25, 35, 50, 75, 1.00
- True Vermonter Shears.....1.15

**PRUNING KNIVES.**

English Stag Horn.....\$1.25 and \$1.50

**BUDDING KNIVES.**

Saynor's Ivory Handle..... \$1.25 to 1.75

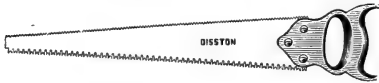

**PRUNING SAW,** (double edge)—80c, 85c, \$1.00

**WATER'S TREE PRUNER.**

- 4 feet..... \$0.75
- 6 "..... .85
- 8 "..... 1.00
- 10 "..... 1.15
- 12 "..... 1.55
- Extra Knives..... .20
- CHISEL PRUNER AND SAW.**
- Combined.....\$1.00



**TREE SCRAPERS**.....50c

**Sand Riddles for Sifting Soil**

18 in. Galvanized, either 1/4 inch, 1/2 inch, 3/4 inch or 1 inch, each \$1.00.

**RUBBER PLANT SPRINKLER**

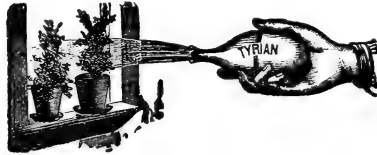

- Medium size.....\$ .75
- Large size..... 1.00

**MASTICA,**—Used in place of Putty.

1/2 gallon can, 75c; 1 gallon can..... 1.50

**MASTICA MACHINE**..... 1.50

**PUTTY BULB**—for glazing..... 1.00

**TARRED MARLINE**—for making straw mats, per lb..... .25

**RAPHIA**—for tying, per lb..... .20

**WOOL TWINE**—soft, for tying, per lb..... .12

**SILKALINE**—green, per spool..... .20

**COARSE TWINE**—Hemp, very strong, per ball..... .25

**FINE TWINE**—hemp, per ball..... .10

**COTTON TWINE**—per ball..... .05

**GALVANIZED ANNEALED GREENHOUSE WIRE**—per lb..... .12

**MOSS** (Sphagnum)—either dry or fresh green, per bbl..... \$1.50 to 2.50

**CORN KNIVES**..... 25c and .50

**GRASS HOOKS**—Common..... 25c to .40

" " English and Concave..... 75

**GIANT GRASS HOOK**..... 50

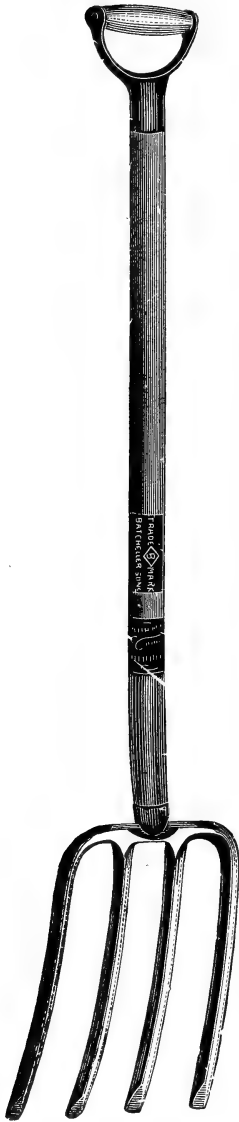

## Spading Forks

### "BATCHELLER'S"

- 4 Tine Long Handle, Flat or Diamond Tine . . . . .85c
- 4 Tine D Handle, Flat or Diamond Tine . . . . .85c
- Manure Forks, Batcheller's.
- 4 Tine Long or D. Handle, 75c
- 5 " " " " " 90c
- 6 " " " " " \$1.10
- Potato Hooks, Batcheller's.
- 5 Tine "Standard," 60c
- 6 " " " " " 65c
- Barley Forks (with bail) 1.25

- Hay Forks, Batcheller's.
- No. 0, 3 Tine (boys) straight handle . . . . .25c

- No. 3, 3 Tine bent handle . . . . .55c

The above prices are for forks with 2 8-12, 4 1/4, 4 1/2 feet handle.

Extra long handles, 5 to 10c extra.

## HOES

- Socket, Field, 8 in. blade . . . . .50c
- Shank, Field, 7 1/2 and 8 inch blade . . . . .45c
- Socket, Meadow, 9 and 10 inch . . . . .50c
- Ladies' Hoe, 5 1/4 inch blade . . . . .35c
- Humphrey (tooth hoe) . . . . .75c
- Mortar Hoe (shank) . . . . .70c
- " " (socket) . . . . .75c
- " " (mixer) . . . . .75c

## RAKES

- Steel Garden . . . . .10 tooth . . . . .50c
- " " " " " 12 " . . . . .55c
- " " " " " 14 " . . . . .60c
- " " " " " 16 " . . . . .65c
- Steel Short Teeth . . . . .16 " . . . . .70c
- Steel Heavy Road . . . . .14 " . . . . .1.00
- Electric Welded . . . . .14 " . . . . .40c
- TURF EDGER—or Edging Knife . . . . .60c

## HATCHETS

- Claw . . . . .50c, 60c and 75c
- Shingling . . . . .50c, 60c and 75c
- Axe . . . . .50c, 60c and 75c
- Haines (Lathing and Shingling) . . . . .90c

## RULES

- 1 foot Caliper . . . . .25c and 35c
- 1 " Full Brass Bound . . . . .25c
- 2 " Plain . . . . .10c
- 2 " (heavy joint) . . . . .15c
- 2 " Half Brass Bound . . . . .25c
- 2 " Full " . . . . .30c
- 4 " Z. Z. . . . .25c
- 6 " Z. Z. . . . .40c

## FILES

ALL SIZES—Taper, Slim Taper and Flat Files.

## GLUE

- LEPAGES OR PROGRESSIVE
- Small Bottle . . . . .10c
- Large " . . . . .15c
- Can . . . . .30c

## LEVELS

- 12 inch . . . . . \$ .50
- 30 " . . . . . .90
- 36 " . . . . . 1.00
- 27 " (3 pieces) . . . . . 1.45

## BIT BRACES

- Plain . . . . .75c
- Ratchet . \$1.00, 1.75 and 2.25
- Putty Knives . . . . .25c
- Key Rings . . . . .5c
- Key Chains . . . . .10c, 35c
- Carpenter's Pencils . . . . .5c, 10c

## BITS

- 4-16 . . . . .15c
- 5-16 . . . . .15c
- 6-16 . . . . .18c
- 7-16 . . . . .20c
- 8-16 . . . . .25c
- 9-16 . . . . .28c
- 10-16 . . . . .28c
- 11-16 . . . . .30c
- 12-16 . . . . .30c
- 13-16 . . . . .35c
- 14-16 . . . . .35c
- 15-16 . . . . .38c
- 16-16 . . . . .40c
- Ford's Sets . . . . .4.50
- Gimlet Bits . . . . .10c
- Tapping Bits . . . . .25c
- Gimlets . . . . .10c and 15c



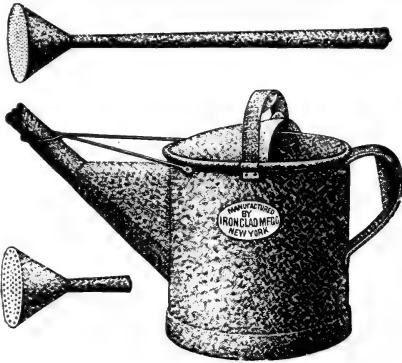

NEW STYLE.

## OUR NEW STYLE WATERING POTS

This is pronounced by Florists to be the very best Watering Pot they have seen. It is made of very heavy galvanized iron, with two copper roses and extra long spout.

6 Quart, - - - - -	\$2.00
8 " - - - - -	2.25
10 " - - - - -	2.50



REGULAR STYLE.

## Regular Style Watering Pots

Galvanized. Painted.

4 Quart,	\$ .50	\$ .30
6 "	.65	.40
8 "	.85	.50
10 "	1.00	.60
12 "	1.25	
16 "	1.50	

## Auto Spray Pump

Self-operating Sprayer, simple, durable, easy to carry and operate. Price with Brass Tank, \$7.00; with Galv. Tank, \$5.50; Extra for Fine Auto. Pop Nozzle, \$1.00.

### The Compressed Air Sprayer

Reservoir made of heavy galvanized iron.  
Price, - - - - - \$1.50



AUTO SPRAY PUMP.

## FRENCH WATERING POT

6 Quart, Galvanized, - - - - -	\$2.25
8 Quart, Galvanized, - - - - -	2.50

## FLOWER BED GUARD

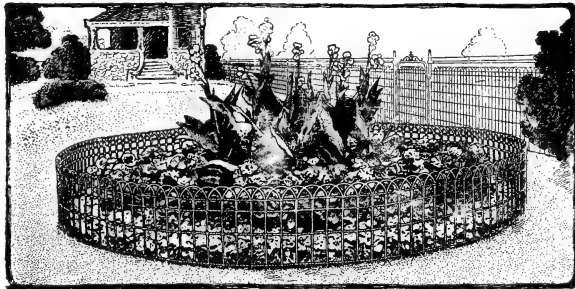

Made of heavy galvanized wires, 16 in. high.  
Per lineal ft. 10c.

Prices below are List

Prices.

Discounts According to Quantity.



**Round Tile—(13 inches long)**

The sizes named are inside measurements.

Size	Price per 1000 pieces	Weight 3,000 Lbs.
2 inch	\$15.00	3,000
2½ "	20.00	4,000
3 "	25.00	5,000
4 "	45.00	7,000
5 "	75.00	10,000
6 "	100.00	12,500
7 "	125.00	15,000
8 "	150.00	17,000
10 "	250.00	26,000
12 "	350.00	35,000

**Sole Tile—(13 inches long)**

Size	Price per 1000 pieces	Weight 3,000 Lbs.
2 inch	\$15.00	3,000
3 "	25.00	5,000
4 "	45.00	8,000
5 "	75.00	11,000
6 "	100.00	14,000

**List Prices on Akron Sewer Pipe**

We carry a heavy stock of this on hand.

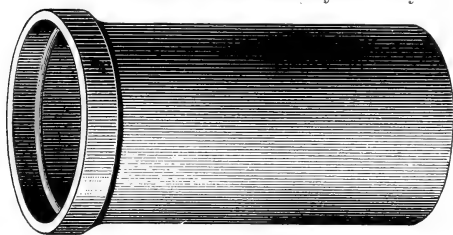

Size	Weight per ft.	Price per ft.
3 inch	8 lb.	\$0.16
4 "	10 "	.20
5 "	12 "	.25
6 "	16 "	.30
8 "	24 "	.50
10 "	34 "	.75
12 "	48 "	1.00
15 "	67 "	1.35
18 "	84 "	1.70
20 "	100 "	2.25
24 "	140 "	3.25

Discount on application.

**Standard Flower Pots and Saucers**

Size	Wt. Per M	Pots. per hundred	Pots. \$	Saucers	P. & S.
1¾ inch	100 lb.		.70		
2 "	150 "		.80		
2½ "	300 "		1.10		
3 "	400 "		1.40		
3½ "	600 "		1.70	\$1.40	\$3.10
4 "	750 "		2.20	1.80	4.00
4½ "	1000 "		3.00	2.00	5.00
5 "	1300 "		4.00	2.25	6.25
5½ "	1600 "		5.00	2.50	7.50
6 "	1950 "		6.00	3.00	9.00
6½ "	2500 "		8.00	3.50	11.50
7 "	3350 "		10.00	4.00	14.00
8 "	4400 "		14.00	6.00	20.00
9 "	6600 "		20.00	8.00	28.00
10 "	8700 "		27.00	10.00	37.00
11 "	11250 "		36.00	12.00	48.00
12 "	14500 "		50.00	15.00	65.00
13 "			75.00	20.00	95.00
14 "	each		1.00	.25	1.25
15 "			1.50	.30	1.80
16 "			2.00	.35	2.35
18 "			3.00	.50	3.50



We are prepared to give you the right figures on first-class Earthen Ware, on application.



## SEED OR BULB PANS

6 inch Round,  
 8 "  
 10 "  
 12 "  
 14 "

Per 100	16 inch, each,	\$1.30
\$ 6.00	18 " " "	2.00
10.00	20 " " "	2.70
18.00	22 " " "	4.00
35.00	24 " " "	5.40
75.00		

### Fire Clay Flue Lining (2 FOOT LENGTHS)

Outside Measure.	Weight.	Price per ft.
4 1/2 x 8 1/2 in	14 lbs.	\$.30
4 1/2 x 13 "	19 "	.45
4 1/2 x 18 "	40 "	1.00
6 x 12 "	22 "	.50
6 x 16 "	24 "	.75
7 x 7 "	18 "	.35
*8 1/2 x 8 1/2 "	20 "	.45
*8 1/2 x 13 "	23 "	.65
8 1/2 x 18 "	45 "	.90
*13 x 13 "	40 "	.85
13 x 18 "	57 "	1.20
14 x 16 "	50 "	1.10
18 x 18 "	75 "	2.00

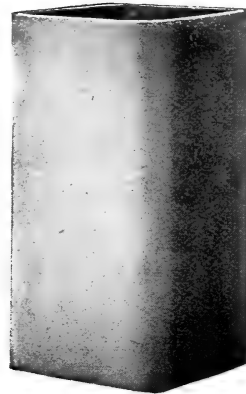

Openings and Register 50 per cent. added.  
 \*Sizes most used.

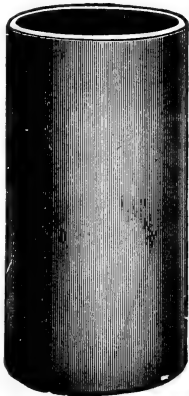

### Cut Flower Vases—Earthen

6 inch, per dozen,	\$2.00	10 inch, per dozen,	\$3.00
8 " " "	2.50	12 " " "	4.00

### Fibre Ware—Florists' Vases

No. 0.	8x13,	-	-	-	-	-	-	60c.
No. 1.	5 1/2 x 10,	-	-	-	-	-	-	50c.
No. 2.	4 1/2 x 9,	-	-	-	-	-	-	45c.
No. 3.	4x6,	-	-	-	-	-	-	35c.
No. 4.	3x4 1/2,	-	-	-	-	-	-	25c.
No. 11.	5 1/2 x 18,	-	-	-	-	-	-	60c.
No. 22.	4 1/2 x 15,	-	-	-	-	-	-	50c.

### Indurated Fibre Ware Saucers WILL NOT SOAK WATER.

4 inch, each,	8c.	10 inch, each,	16c.
6 " " "	10c.	12 " " "	18c.
8 " " "	14c.	14 " " "	20c.

(No. 126.)

## THE NEW BRANDT SPRAYER

Made of Galvanized Steel, holds about 3 gallons. Pump is separate from the tank, which device enables the operator to pump air into the tank while walking.

Price of Sprayer,	\$5.50
" No. 2 Cap for Bordeaux Mixture, extra,	.35
" Double Nozzle,	1.50
" Tree " "	1.50



**Special Hose Reel**

Carries 200 feet Hose, - - - Price, \$2.25

**Eclipse Hose Reel**

Price \$1.00

**Tubular Iron Hose Reel**

Light weight, high wheels.

For 100 ft. Hose, \$2.85. For 150 ft. Hose, \$3.15.

For 500 ft. Hose, \$5.00.

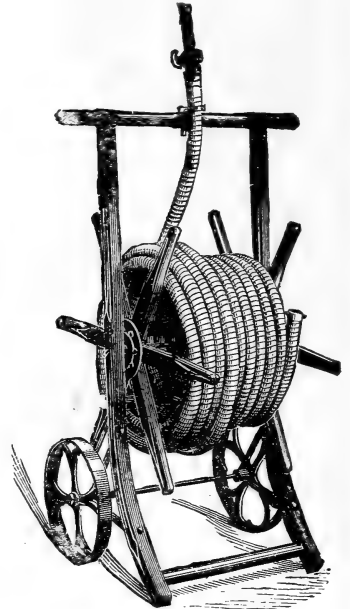
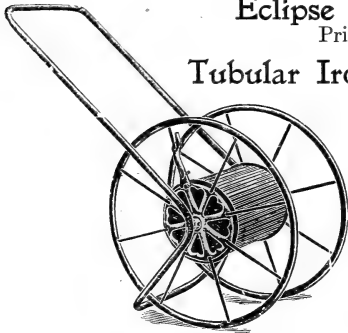

Special Hose Reel.

**Rubber Hose**

Corrugated Hose,—Best quality, very pliable, 3/4 in., 20c.; 1/2 in., 19c. per ft.

Howard & Morrow's "Special 7 Ply," a very strong high grade hose, 3/4 in., 19c. per ft., 1/2 in., 18c. per ft.

Howard & Morrow's "Leader,"—An excellent, high grade, 3-ply hose, 1/2 in. coupled, 15c., per ft., 3/4 in. coupled, per ft., 16c.

"Spider,"—Good Hose for the money, 3/4 in. coupled, per ft., 10c.; 1/2 in., coupled, 9c. ft.

- HOSE COUPLINGS,—Complete set, \$ .25
- " Bands and clamps, each, .05 and .10
- " Menders, (Hudson set of 6 with pliers), .75
- " Menders, "Cooper's," 3/4 in., 1/2 in., each, .10
- " Washers, per dozen, .10
- " Pliers, .10
- " Nozzle Holders .25
- " End for connecting hose with faucet .50

LAWN SPRINKLER,—Four revolving arms, \$1.50 and \$1.75.

BALL NOZZLE LAWN SPRINKLER,—Throws fine spray, like rain. Price 75c.

DELUGE LAWN SPRINKLER,—A nice little sprinkler, with runners, 75c; without runners, 50c.

HOSE NOZZLE,—Throws spray or solid stream by turning thumb screw, 75c.

VERMOREL SPRAY NOZZLE,—75c.

FROG LAWN SPRINKLER,—Throws a splendid spray. Price 50c.

TWIN COMET LAWN SPRINKLER, each \$5.

KINNEY PUMP,—\$2.00.

ROSE SPRAY NOZZLE,—\$1.00.

Chisel Blade Weed Cutter, with Foot Rest, 60c.

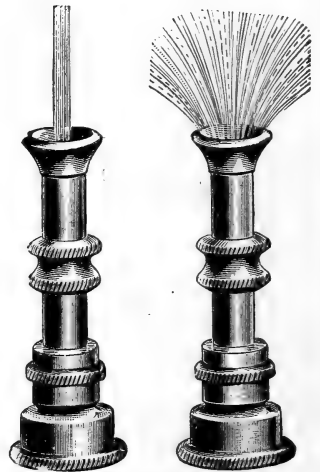

Boston Hose Nozzle, 50c.

Pastime Weed Extractor, with 4 ft. handle, 25c.

**BRASS PLANT SYRINGE**



**H** Barrel 18 in. x 1 1/2 in. diameter.

No. 11. Barrel 18 in. long, 2 sprays, 1 Stream Rose, elbow joint,

\$5.50

No. "G" Barrel 16 in. long, 1 spray, 1 stream Rose,

\$4.50

## Coldwell Improved Horse Lawn Mower

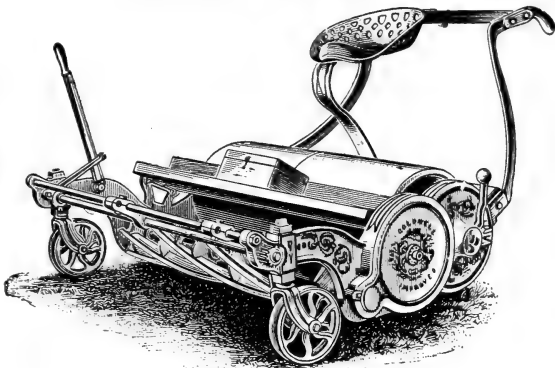

We guarantee this to be the best and most perfect Horse Lawn Mower manufactured. It is provided with shafts, seat and side draft attachment. Each mower is guaranteed to give complete satisfaction. The new lever attachment for raising knives from the ground and adjusting heights of cut is very convenient.

Price: 30 in., \$65.00; 35 in., \$78.00; 40 in. \$95.00.  
Add \$10.00 to above prices for 6 blade mowers.

## Coldwell's Motor Lawn Mower

A practical Mower for large lawns, and especially good on Putting Greens, cuts very evenly.

	Weight.	Width of Cut.	Horse Power.	Price.
Style B	1000 lbs.	35 in.	4	\$750.00 f. o. b. Newburg
" C	1300 "	40 "	8	850.00 " "
" D	2000 "	40 "		1500.00 " "

## Imperial High Wheel Lawn Mower

This mower is not surpassed by any Lawn Mower in the market. It is easy running, does the best of work and its construction is such that it will outwear any lawn mower made.

Price: 14 in., \$8.00; 16 in., \$9.00;  
18 in., \$10.00; 20 in., \$11.00  
Add \$1.00 to above prices for 5-blade mower.

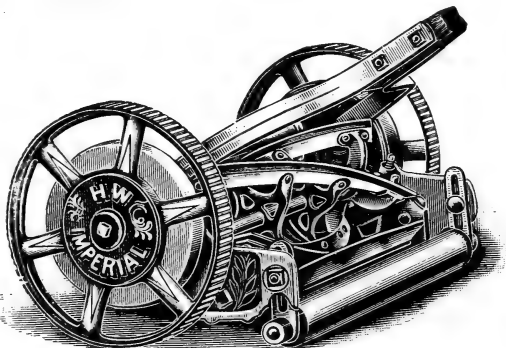

## The Cadet Lawn Mower

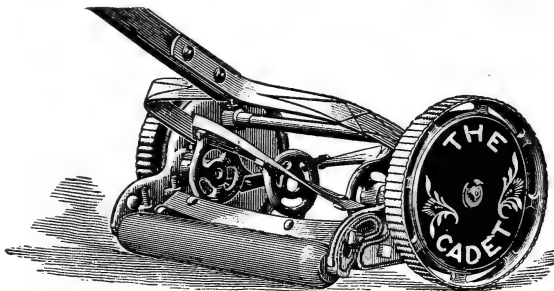

This is an excellent low price mower and should not be confounded with the cheap mowers that are on the market, many of which are worthless. The Cadet is a well made, substantial mower.

Price 14 inch \$4.00  
Price 16 inch, 4.50

## The Newport High Wheel Mower

A medium priced mower,  
and a splendid machine.

16 inch, \$6.50

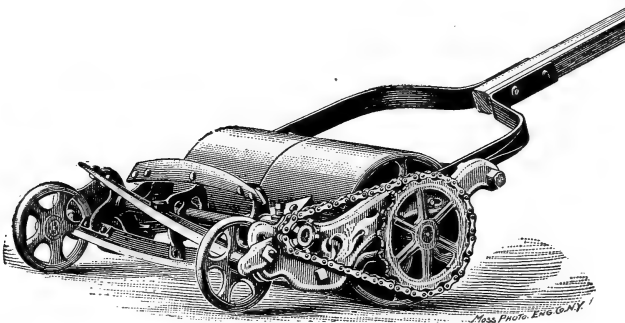
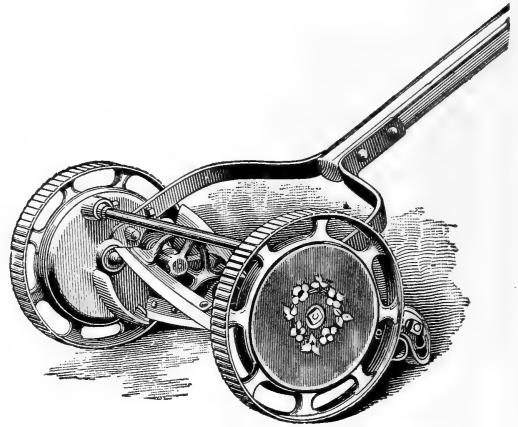

## CHAIN ROLLER MOWER

This is designed especially for use on borders and on the edges of drives and walks. It runs very easily and is quite a necessity on all large lawns.

PRICE—4 Blade Mower, 12 in. \$12.00; 14in. \$13.00; 16 in. \$14.00; 18 in. \$16.00.

PRICE—6 “ “ “ \$13.00; “ \$14.00; “ \$15.00; “ \$17.00.

GRASS CATCHER BOXES FOR CHAIN MOWER—12 in. \$1.50; 14 in. \$1.60, 16 in. \$1.85; 18 in. \$2.00.

Grass Catcher for high wheel mowers, \$1.50 each.

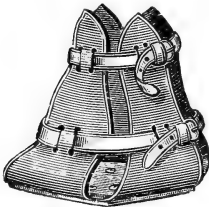

## Horse Lawn Boots

To prevent horse from marking the lawn.

Price per set of 4, \$9.00, \$10.00 and \$11.00.

## Capital Lawn Edger and Trimmer

For cutting grass borders and trimming edges of walks.

Price complete, \$6.00.



## THE GEM LAWN CLEANER

A revolving fan with metal teeth, takes up leaves, dead grass, stones, etc. Price \$16.00

## Water Barrel and Truck

Complete with 2½ in. tire,	Price \$11.00
TRUCK without barrel,	“ 8.75
HAND CART BOX,	“ 3.00





# INSECTICIDES

(CONTINUED.)

**ARSENATE OF LEAD**—1 lb. 25c., 5 lbs. \$1.00.

**PARIS GREEN.** We Guarantee Our Paris Green to be Absolutely Pure. Put up in  $\frac{1}{4}$ ,  $\frac{1}{2}$ , 1 and 2 pound boxes. Prices according to the market.

**BUG DEATH.** An insecticide for destroying Potato, Squash and Cucumber Bugs, Currant worms, etc.

Price 1 lb. package, \$ .15  
 " 3 lb. " .35

Price 5 lb. package, \$ .50  
 " 12 $\frac{1}{2}$  lb. " 1.00  
 " 100 lb. keg 7.50

**Copper Solution.** To prevent blight, rot and mildew, qt. \$70.

**Hammond's Slug Shot.** Destroys insects injurious to house and garden plants, potatoes, vegetables, and fruits of all kinds. Comes all ready for use. 5 lb. packages, 25c.

**Grape Dust.** For the prevention of mildew, 5 lb. pkg. 35c.

**Bordeaux Mixture.** To prevent Potato Blight, Mildew and other Fungus growths on plants, etc. Dilute with 25 to 50 parts water. Per quart can, 35c; per gal. can, \$1.00

**California Wash.** For San Jose Scale, per gal. \$1.25.

**Tobacco Dust.** A very fine dry powdered tobacco. Price per lb. 10c, 5 lbs. 35c.

**Tobacco Stems** for fumigating. In bales of 100 lbs. each, 2c per lb.

**Hellebore.** The common remedy for currant and rose bushes. Price  $\frac{1}{2}$  lb. box, 15c; 1 lb. box, 25c. Subject to market change.

**Kerosene Emulsion,** for scale on trees and for insects on plants and trees. Per gal. \$1.00.

**Flowers of Sulphur.** Much finer and preferable to Flour of Sulphur, for the prevention and cure of Mildew on grape-vines, roses, etc. Price per lb., 10c; 10 lbs., 60c.

**Fir Tree Oil.** An all round insecticide for Greenhouse use. Price per pint can, 90c.

**Fir Tree Oil Soap.** Per can 25c and 75c.

**Tobacco Extract.** A powerful extract of Tobacco, for destroying Lice, Red Spiders, Mealy Bugs, etc., by vaporizing. Price per pint, 30c; quart, 60c.

**Whale Oil Soap.** Makes an excellent wash for trees and plants, and for smearing on the trunks of trees, to prevent worms from crawling up. Excellent for destroying the Green Worm on Cabbages. Price per lb., 15c.

**Whale Oil Soap and Tobacco.** Per lb. 20c.

**Scalecide.** For spraying, especially good for San Jose Scale. 1 gal. \$1.00, 5 gals. \$3.50

**Cyanide of Sodium.** Per lb. \$1.50.

**Seal Oil Soap.** A valuable insecticide for syringing and washing plants. Box 25c.

**Sheep Dip—Leggett's.** Quart can, 75c;  $\frac{1}{2}$  gallon can, \$1.25.

**Sheep Dip—Cooper's.** In powder form, pkg. makes 25 gallons. Price 50c.

**Nikoteen.** Put up in bottles only. Each bottle represents the extracted product of 150 lbs. tobacco. Price per bottle, \$1.60.

**Nikoticide.** A powerful tobacco insecticide for fumigating in greenhouses. Per can, \$1.25 and \$2.50.

**Aphis Punk.** For fumigating Greenhouses. Three rolls will fumigate 100 foot house One doz. rolls in box. Price per box, 60c.

**X L ALL.** Vaporizing Compound for fumigating, per bottle, \$2.25.

**Nico-Fume.** A tobacco paper insecticide for fumigating. Per can, 85c; and \$4.00.

**X L ALL.** Liquid insecticide, for spraying and sponging to destroy insects, medium can, \$1.25; large can, \$2.25.

**Weed Exterminator—(Herbicide)**—For use on walks, drives and gutters. 1 gallon, \$2.25, 2 gallon, \$4.00; 5 gallon, \$7.50.

**Weed Killer, Sterlingworth.** In powder form, dissolve in water. 1 lb. pkg. makes 15 gals., 50c; 3 lb. pkg. makes 45 gals., \$1.25.

**“Perfection” Plant Food.** For house plants. Small pkg., 10c. Large pkg., 25c.

**Plant Food.** “Bonora” ¼ lb., pkg. 25c., 1 lb. pkg. 50c., 5 lb. pkg. \$2.50.

**Potash.** Per box, 15c.

**Chloride Lime.** A valuable disinfectant. Price 1 lb. box, 15c; ½ lb. box, 10c.

**Sulpho-Naphthol.** A modern cleanser and purifier. Makes everything clean and healthful. One of the best disinfectants known. Price, small bottle, 25c; medium bottle, 50c; large bottle, \$1.00; one gallon can, \$3.00; five gallon can, \$12.50; ten gallon can, \$20.00.

**Sulphuric Acid**--per bottle, 75c.

**Sultar.** Used for same purposes as Sulpho-Naphthol. Price the same.

**Lamp for Fumigating.** Complete with stand, 75c.

### Imperial Liquid Plant Food

Price per pt. bottle, 25c.

Per qt. bottle, 40c.

### Boston Pattern Fumigator

No. 1. 13 in. diameter, 20 in. high, - - - \$3.25

No. 2. 14 in. diameter, 24 in. high, - - - 4.00

No. 3. 16 in. diameter, 28 in. high, - - - 5.00

### Dickey Bug Death Shaker

For distributing Bug Death, Slug Shot, etc. Price 25c.

### Campbell Vaporizer

The only safe machine to use in vaporizing sulphur in greenhouses. Large size, \$8.00; medium size, \$7.00.

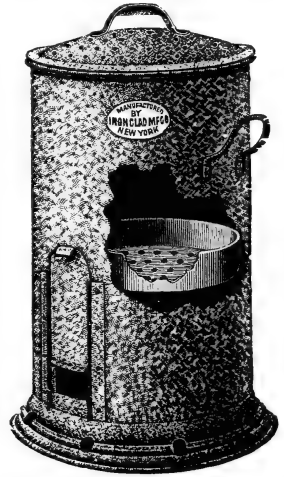

BOSTON PATTERN FUMIGATOR

**BELLOWS OR GUN**—For applying dry, Paris Green, Hellebore, Tobacco Dust, Sulphur, etc - - - \$1.00

Insect Powder Gun, small, 10c

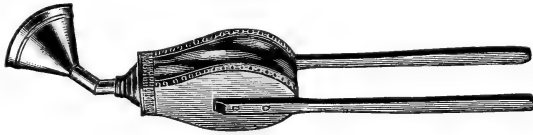

### Leggett's Improved Champion Dry Powder Gun

Price Complete, \$7.50

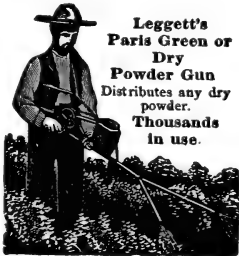

### Knapsack Sprayer Copper Tank Holds Five Gallons

Has pump to keep air pressure in sprayer while using.  
\$12.00 and \$16.00

### Leggett's Little Giant Duster

Similar to Champion but smaller, Price \$5.50

Little Brownie Duster, 4.00



**SHOVELS**

	Long Handle Round.	D Handle Round.	Long Handle Square.	D Handle Square.
Subject to change in market.				
Ames, - - -	\$1.10	\$1.10	\$1.10	\$1.10
Blair, - - -	.90	.90	.90	.90
Lee, - - -	.90	.90	.90	.90
Brown, - - -	.75	.75	.75	.75

**STEEL SCOOPS**

	Polished Plain.	Polished Ex-Strapped.
SANDERSON'S No. 2, - - -	\$ .90	
No. 3, - - -	.95	
No. 4, - - -	1.05	
No. 5, - - -	1.10	
No. 6, - - -	1.15	\$1.25
No. 7, - - -	1.20	1.30
STEEL FURNACE SCOOP, - - -		.80
WOOD POTATO SCOOP, .75		
WIRE POTATO SCOOP, 1.75		



PICKS—Adze Eye Railroad, .75 Contractors \$1

**SPADES**

	D. Handle.	Long Handle.
Ames, - - -	\$1.20	\$1.10
Lee, - - -	1.00	1.00
Brown, - - -	.75	.75

**HANDLES**

- Sledge.....\$12 to \$20
- Hammer......06 to .15
- Hatchet......10
- Pat Cross Cut Saw, per pr......25
- Ice Hook......20 to .30
- AXE—See Axes
- Pick......20 and .30
- Long or D. Shovel......25
- Manure Fork......15 to .25
- D. Spading Fork......25
- Long Spading Fork......20
- Hay Fork......15, .20
- Hoe and Rake......10, .15

**BRICK TROWELS.**

- Genuine "Brades" or Rose. \$0.35
- Disston's......75 to 1.25
- Pointing, 4 1/2 inch......30
- " 5 inch......35
- MASONS' Hooks.....\$ .85
- " Floats......85
- Tape Lines, 50 ft......40
- " 75 ft......60, 4.50
- " 100 ft......75, 5.75

**PLASTERING TROWELS**

- Disston's 10 inch..\$1.00
- " 11.....1.25
- " 11 1/2.....1.50

- Masons' Sand Screens.
- Medium.....\$4.50
- Large.....5.00
- Mortar Hods, Steel 1.50
- Brick.....1.25

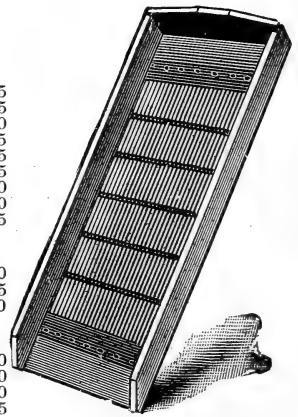
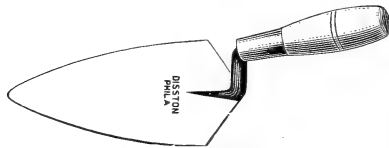

IDEAL WALL PLASTER. Ready for use. Price 125 lb. bag, 75c.  
 PEERLESS NEAT WALL PLASTER—(Mix with two parts sand.) Per 100 lb. bag, 75c.  
 PEERLESS WOOD FIBRE. Ready for use. Per bag, 75c.

MEDUSA—Waterproof Compound in bags of 40 lbs., 13c. per lb.  
 " —White Portland Cement " " 95 " \$1.50 " bag.  
 Special price in quantities.

**LIME AND CEMENT**

FARNAM'S CHESHIRE LIME (none better).  
 PORTLAND CEMENT (best brands only). Atlas, Edison, and Whitehall.

We are in a position to furnish these goods in any quantities, from a pound to any number of carloads, and will figure at store-house, or delivered on the job, as desired. If interested consult us.

- MASONS' CALCINED PLASTER. Per bbl., \$2.25.
- PLASTERING HAIR. "Extra Long Goat." Per bushel, \$35.
- MORTAR RED. Dry, per lb., 3c. Special prices on quantities.
- PAD LOCKS 10c to \$1.00. Special Milk Can Locks, 60c



**SOLID STEEL SCRAPER**

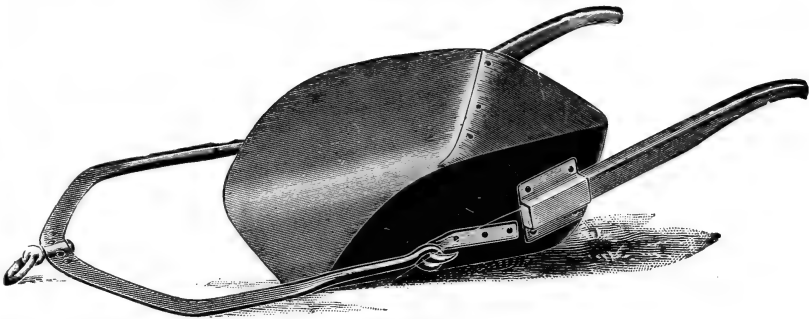

No. 0 Extra Large, Two Horse, Capacity	9 Cubic feet with Runners,	-	\$10.50
No. 1 Large	7 " " " "	-	8.00
No. 2 Medium	5 " " " "	-	7.50
No. 3 One-horse	3 " " " "	-	6.50

**PRESSED STEEL BOWL WHEEL SCRAPER**

No. 1 Capacity 10 cubic feet,	\$36.00	No. 3 Capacity 17 cubic feet,	\$50.00
No. 2 " 13 " "	43.00	End Gates, extra,	5.00



No. 75-A BARROW

**STEEL TRAY WHEELBARROW**

No. 75A.—A perfect end dump contractors barrow, capacity 4 cubic feet,	-	\$5.00
No. 2 Capacity 3 cubic feet, price with steel wheel,	-	\$4.25
No. 4 " 4 " " " " " " "	-	4.75

All Steel Wheel Barrows—from \$6.00 up.

Special prices on quantities.

BOLTED RAILROAD OR CANAL BARROW, common wood wheel,	\$1.50 and \$1.75
" " " " " " patent wood wheel,	2.00
" " " " " " patent steel wheel,	2.50

**WINDOW COAL CHUTE**

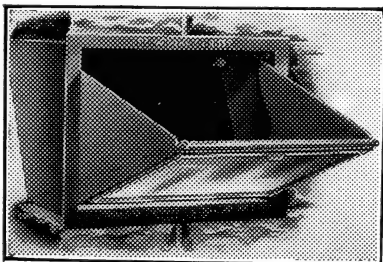

Hopper Opening. Outside Rim. Price	
Size "A" 22 wide—16 high 25 x 19	\$10.00
Size "G" 32 " 24 " 35 x 27	15.00

**MEASURING RODS**

6 ft. long, with brass tips, graduated to 1/8 inch,	\$1.00
10 ft. long, " " " " " 1 inch,	75c
10 ft. long, " " " " " 1/8 inch,	1.25

**CART HARNESS**

NEW ENGLAND PATTERN, \$17.00 to \$26.00.

TWO WHEEL DUMP OR FARM CARTS

STRONG

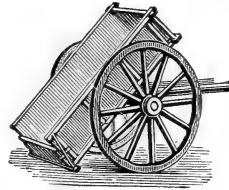

EASTERN MAKE

	Dimensions of Body	Axle	Tires	List Prices
Light,	5 ft. x 3 $\frac{1}{4}$ ft. x 12 in.	1 $\frac{3}{4}$ in. steel	3 inch	\$50.00
Medium,	5 $\frac{1}{2}$ ft. x 3 $\frac{1}{2}$ ft. x 12 in.	1 $\frac{3}{4}$ in. "	4 "	55.00
Heavy,	5 $\frac{1}{2}$ ft. x 3 $\frac{1}{2}$ ft. x 12 in.	2 in. "	4 "	60.00
Shifting Side and Front Boards, extra,				7.50

WATSON DUMPING WAGON

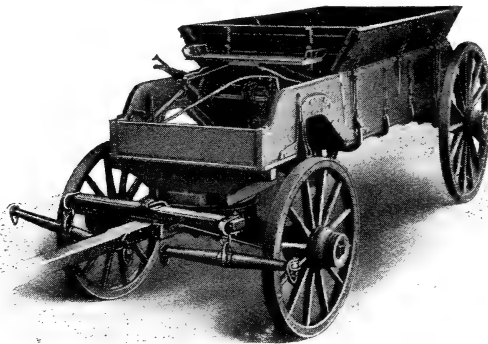

The Best Bottom Dumping Wagon built.

1 $\frac{1}{2}$ yard capacity,	3 inch Tire,	Bottom lined,	Flaring Side-boards,	\$140.00
2 "	4 "	Full "		\$165.00

THE ADRIANCE BUCKEYE MOWER

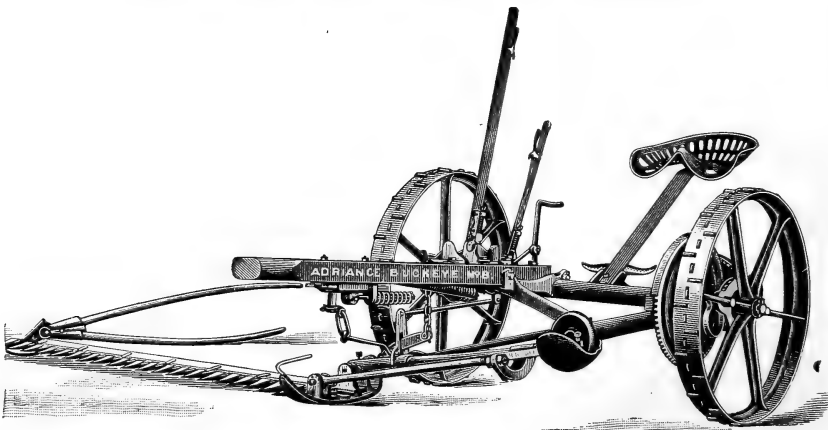

The Adriance Buckeye Mowers have long been considered Standard Goods, and to-day are as good as are made. They are made both in the Buckeye Gear and Chain Gear.

One-Horse, 3 ft. 6 in. or 4 ft.	Either chain or Standard	-	-	-	-	-	\$44.00
Two-Horse, 4 ft. 6 in.	" " " "	-	-	-	-	-	48.00
" 5 ft.	" " " "	-	-	-	-	-	49.00
" 6 ft.	" " " "	-	-	-	-	-	52.00

**THE OSBORNE COLUMBIA MOWER**

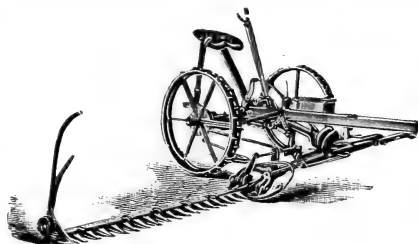

The Osborne Columbia Mower is a reliable, serviceable, up-to-date Mower. A machine perfect in detail, neat in design, light in draft: has roller bearings and all modern improvements.

3½ ft. cut, B Frame,	Price \$44.00	5 ft. cut, D Frame,	Price \$51.00
5 ft. cut, C Frame,	“ 49.00	6 ft. cut, D Frame.	“ 52.00

**STANDARD GEAR BUCKEYE MOWER**

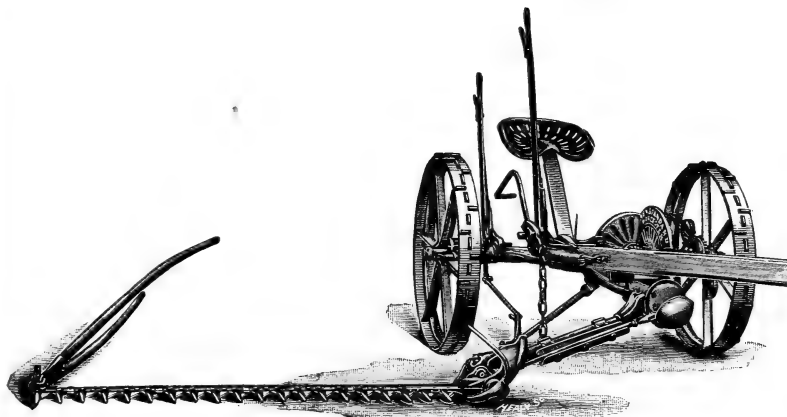

**SIMPLE, DURABLE, AND A VERY STRONG MOWER.**

One-Horse, 3 ft. 6 in.	- - - - -	\$44.00
“ 4 ft.	- - - - -	44.00
Two-Horse 4 ft. 6 in.	- - - - -	48.00
“ 5 ft.	- - - - -	49.00

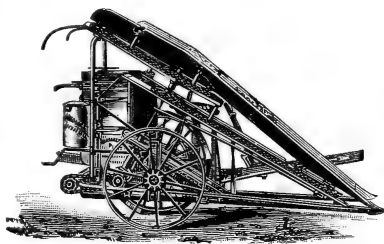

**THE ADRIANCE CORN BINDER.**—This is a splendid working, strong and substantial machine, and backed up by the well known Adriance Buckeye people. Let us show you this machine. We guarantee it.

**THE “NEW CENTURY” CORN BINDER.**—Has an excellent field record, has all the latest improvements. We certainly can suit you on a Corn Binder. Before you buy let us talk with you.

## WALTER A. WOOD MOWING MACHINE

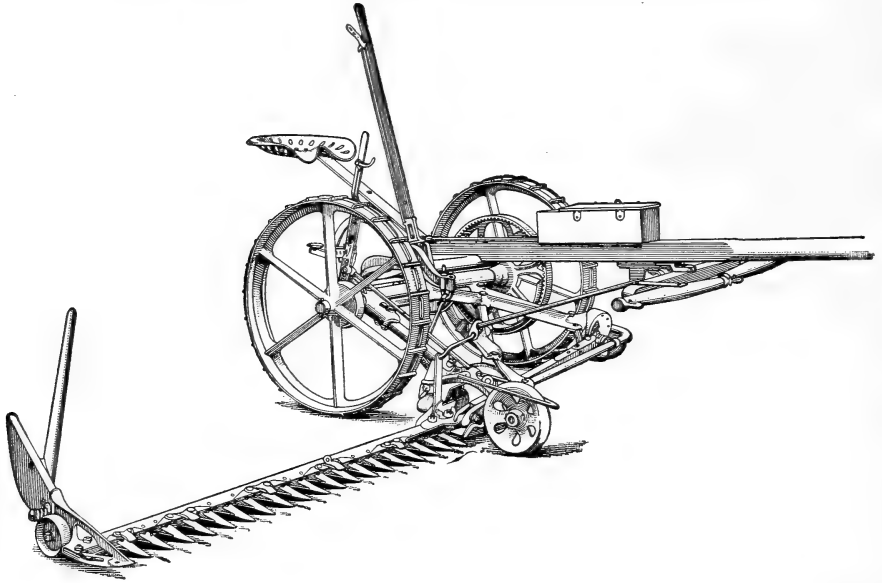

The Wood Machines are well and favorably known the world over. The following styles and sizes are adapted to this section.

Tubular Steel, or Admiral, One Horse,	4 ft.	cut,	\$44.00
“ “ “ Two Horse,	4 “ 6 in.	“	48.00
“ “ “ “	5 “	“	49.00

## WOOD STEEL HAY TEDDER

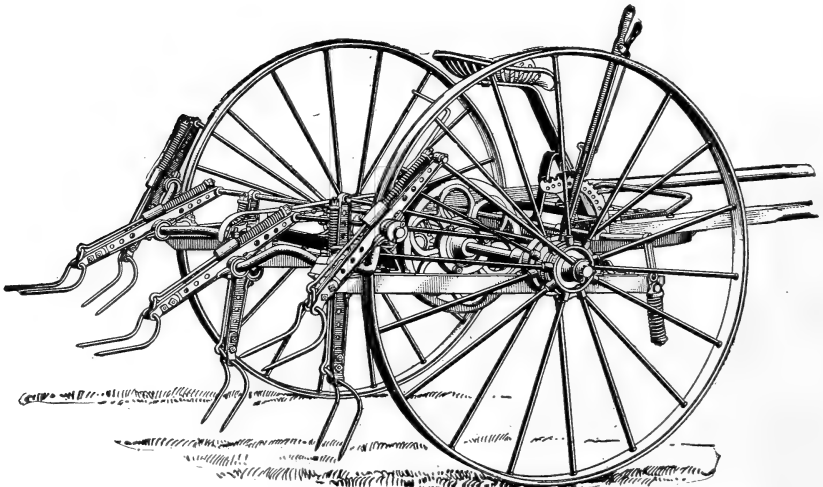

Built of steel throughout, has six forks, is strong and durable, adjustable for one or two horses. Price \$40.00.



**THE OSBORNE STEEL TEDDER**

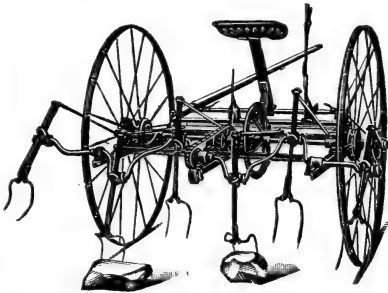

All steel and fully warranted.

Does excellent work.

Price 6 Fork Tedder, - - - - \$42.00

Price 8 Fork Tedder, - - - - \$49.00

**THE THOMAS TEDDER**

VERY LIGHT RUNNING AND DURABLE.

Thomas 6 Fork.—No Fork outside the wheel, Combination pole and shafts, \$44.00  
 Thomas 8 Fork.— “ “ “ “ Pole only, 50.00

**NEW YORK CHAMPION RAKE**

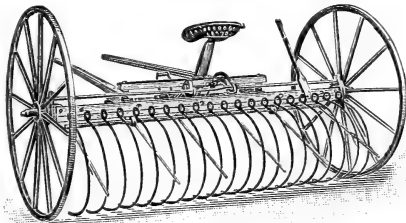

The Champion is too well known to need an extended description. It is a very strong, easy and thorough working rake. It has stood the hard tests of New England work for years, and today is as popular as any rake we know of.

8 ft. Wood Rake (26 teeth), \$25.00

9 ft. Wood Rake (26 teeth), 28.00

**NEW  
Worcester  
RAKE**

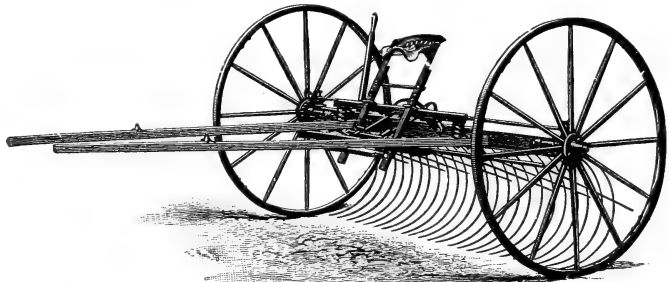

This Rake is exceptionally well made, has 24 sled runner steel teeth, will rake any kind of hay, and can be operated by any one that can drive a horse. Price, \$25.00

**THE WOOD HAY RAKE**

A first class self-dump rake—All steel, arranged for either one or two horses.

8 ft—24 tooth Rake, - - - - - \$26.00

9 ft—26 tooth “ - - - - - 28.00

DRAG RAKE.—For raking after load. Price, - - - - - .75

**THE YANKEE HORSE RAKE**

A very well known and thoroughly reliable rake, - - - - - Price, \$24.00

**THE ADRIANCE BUCKEYE REAPER AND BINDER**

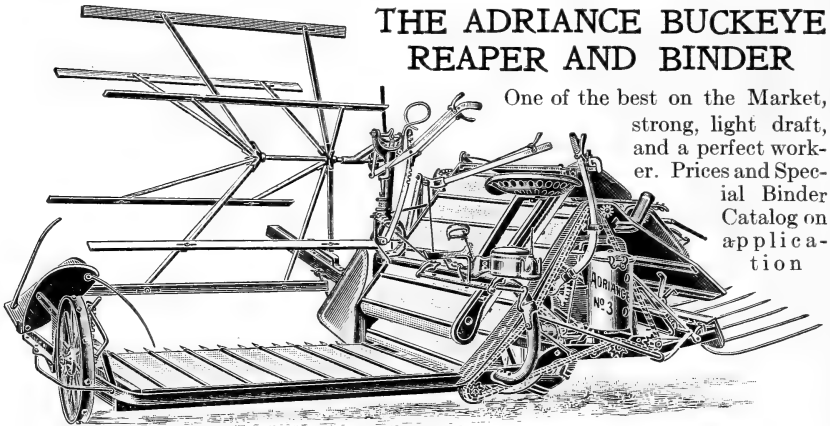

One of the best on the Market, strong, light draft, and a perfect worker. Prices and Special Binder Catalog on application

**HAWKEYE HAY LOADER**

Will take hay from the swath or light windrows and windrows made with the C. B. & Q. Side Delivery Rake. Rakes against and to the hay and not from it. Price \$70.00

**C. B. & Q. Side Delivery Rake**,—The advantage of a Side Delivery Rake is, the Hay Loader can follow the rake, taking up the hay as fast as raked. - - - Price \$60.00

**Hand Hay and Lawn Rakes**

Extra, 3-bowed, Hay, - - -	\$ .35	No. Brand, Hay, - - - -	\$ .15
No. 1, 3-bowed, - - - -	.30	Extra Wood Lawn, - - -	.35
Extra, 2-bowed, - - - -	.30	No. 1 " " - - - -	.25
No. 1, 2-bowed, - - - -	.25	Leaf Guard, " - - - -	.35

**WIRE LAWN RAKE**,—Reversible, 50c.

**SCYTHE SNATHS**

Ash - - - - -	\$ .75	Ash Bush, - - - - -	.85
---------------	--------	---------------------	-----



**SCYTHES.**

Clipper, - - - - -	\$ .85
Solid Steel, - - - - -	.85
Our Special, Solid Steel, - - -	1.00
Bush, - - - - -	.85
Bramble, - - - - -	.85
Grain Cradle, - - - - -	1.25
Snath Wrenches, - - - - -	.05
" Loops, - - - - -	.10

**SCYTHE STONES,**

English Round, - - - - -	\$ .20
Emery Round or Cigar, - - - -	.10
Eagle Emery, - - - - -	.25
Emery Rifles, - - - - -	.10
Ragg (fine), - - - - -	.10
Red End (coarse), - - - - -	.10
Silver Grit, - - - - -	.10
Old Norwich, - - - - -	.10
Old Norwich (hand-made), - - -	.25

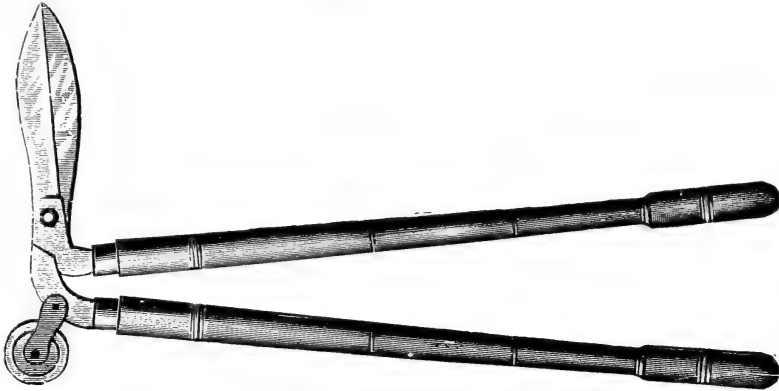

<b>BORDER SHEARS</b> —Saynor's	9 inch, plain,	- - - - -	\$2.50
"	" " " 9 "	with wheel,	- - - - - 2.85
"	" " " 10 "	plain,	- - - - - 3.25
"	" " " 10 "	with wheel,	- - - - - 3.50

**HEDGE SHEARS**

"Saynor's,"	9 inch,	\$2.00
"Saynor's,"	10 "	2.50
Notched to cut 1/2 in. branches, extra,		.25

**BRANCH OR LOPPING**

"English,"	medium,	\$2.50
"English,"	heavy,	3.50
American,		1.00 and 1.25



**BUSH or BILL HOOKS**

Light, (handled)	\$ .85
Heavy, "	1.00

Mattocks, (Grub Hoes) \$ .65



Axe Mattocks,	\$ .85
Pick Mattocks,	.85

**SAWS**

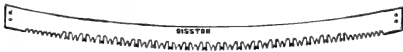

**DISSTON**

Cross Cut—Narrow, including handles,	5ft.	\$1.25
" " " " " "	5 1/2 ft.	1.50
" " " " " "	6ft.	1.75

**SIMMONDS**

Cross Cut, —Narrow, including handles,	5 ft.	\$1.75
" " " " " "	5 1/2 ft.	2.00
" " " " " "	6 ft.	2.25

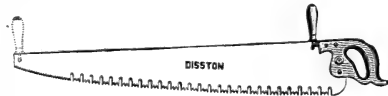

Cross Cut, one man	3 1/2 ft.,	\$1.75
" " " "	4 ft.,	2.00
" " " "	4 1/2 ft.,	2.25

<b>Buck Saw</b> —Either narrow or wide blade,	75c and \$1.00
" Blade only,	50c
" Frame only,	25c
" Strainers,	10c



Carpenters' "Cut Off," Disston's	20, 24 and 26 in., in two grades,	\$1.00 to \$1.85
Quinnipiac,	\$1.00 Imp,	50c, 60c

<b>SAW SETS,</b>	75c and \$1.00
<b>ICE SAWS,</b>	4 ft. \$3.50   4 1/2 ft., \$4.00
Cart Saws,	1.00

**MEAT SAWS**

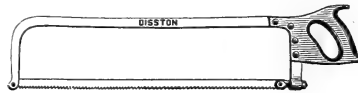

Family Size,	50c	18 inch Disston's,	\$1.50
17 in. Disston's,	\$1.40	19 "	1.65

**AXES**

Connecticut patterns, 75c

**OUR BEST AXE, \$1.00.**

Axe Stones,	5c	Axe Wedges,	5c
Axe Handles, x,	25c and 30c	Boys' Axes, hand'l'd,	75c

**GRAFTING WAX**

Trowbridge,	1/4 lb. stick,	- - - - - 10c
"	1/2 lb. stick,	- - - - - 20c
"	1 lb. stick,	- - - - - 30c

**GRAIN CRADLES**

Turkey Wing, 4 fingers,	\$2.75 and \$3.50
Cradle Fingers,	20c each
<b>HAY KNIFE,</b> Lightning,	\$1.00
<b>FLAILS,</b>	.65
<b>CARPENTERS' SQUARES,</b>	75c, 1.00
<b>SAW BUCKS,</b> Folding	25c, 35c, 50c

The Diamond Steel Track Hay Carrier

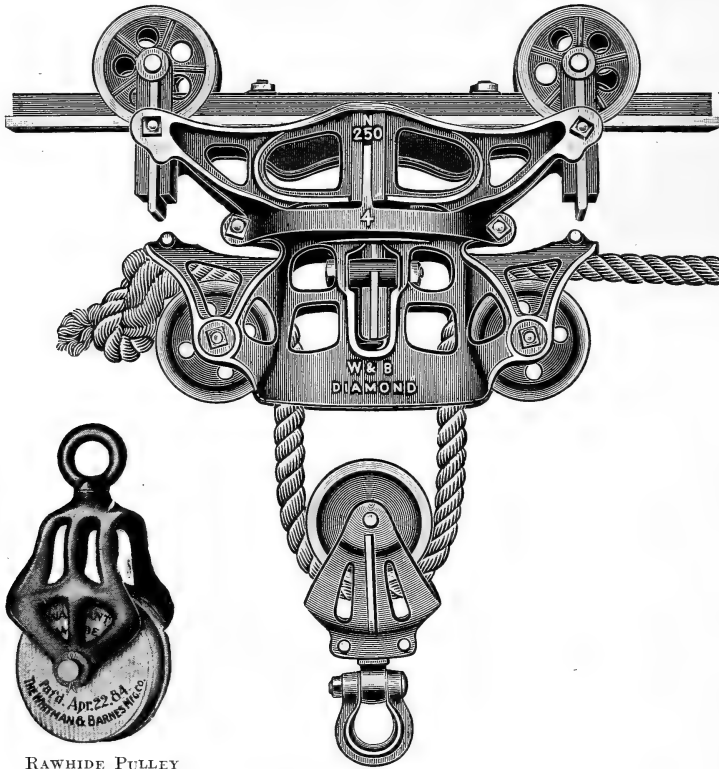

In the 17 years that we have sold Hay Carriers, we have never had a complaint; every one has done its work perfectly. ANY ONE CAN PUT THEM UP. We would be pleased to give you figures on the Carrier at the store or put up in your barn ready for use. The Diamond can be arranged to unload hay from the load to the mow, or from the mow to the wagon. We would like to refer you to parties who are using them.

Should you wish a cheaper equipment than our Diamond we can furnish it.

RAWHIDE PULLEY

Pulleys, Etc.

Raw-Hide Bushed Pulleys,	\$ .75
Raw-Hide Knot-passing Pulleys	.75
Wood Sheave Pulleys,	.35
Iron Pulleys,	.35
Steel Track, per ft.,	.15
Steel Track Hangers, per doz.,	1.25
Rafter Brackets, per doz.,	1.25
Pulley Hooks, each,	.15
Drive Screws, per gross,	1.00
Diamond Car,	6.00
Pulley Hoisters, each,	.30



ROPE HITCH  
30 cts.

"Bale Ties" or "Hay Wires"

Stock sizes—7 ft. 3 in., and 9 ft.

Prices variable.

Any style or length Ties to order.

ROPE

We carry in stock pure Manila Rope, sizes from 1/4 inch to 1 inch; prices according to market.

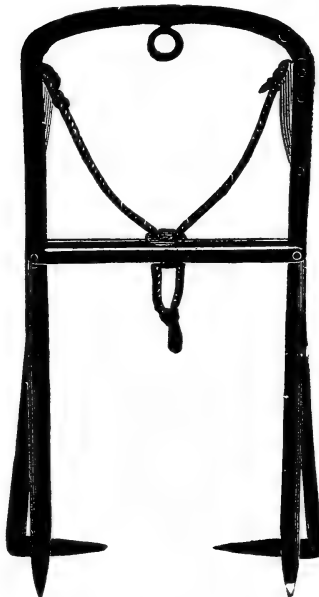

DOUBLE HARPOON FORK, Long, \$1.25 to \$2.00.  
"Extra Long, 2.00.  
GRAPPLE FORK, 4 tine, 5.50.  
" " 6 " 6.50.

## MOWING MACHINE KNIVES, SECTIONS, GUARDS AND REPAIRS

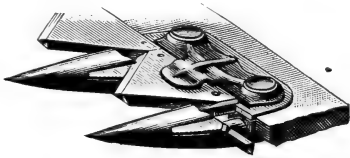

The furnishing of these goods is an important part of our business. We are in a position to supply you with PARTS of any Mowing Machine, Rake, Tedder, Plow, Harrow, or most any Agricultural Implement made; and it is always best if possible, to bring or send the old parts to insure a fit. It is important that you use the Best Knives and Sections.

We sell only the Best Sections. We positively refuse to handle a cheap section. The best are worth the money, the others are worth nothing.

EVERY ONE IS WARRANTED.

## OILERS

No. 1. Zinc Oiler, (Buckeye).....	15c
No. 2. " " (tall).....	20c
No. 3. " " (Cut).....	20c
Sewing Machine Oiler.....	10c and 15c
Steel Oiler.....	30c, 40c and 50c
Oil Can, One Gallon.....	25c and 50c
Oil Can, Five Gallon.....	\$1.00 and 1.50

## FAUCETS

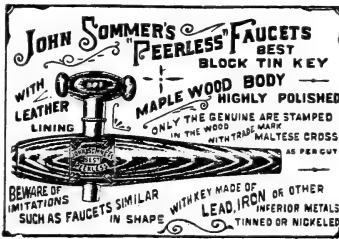

No. 1. Metal Key Somers' Best.....	35c
No. 2. Metal Key Somers' Best.....	40c
Ivy Wood, 6 inch.....	10c
" " 7 ".....	15c
" " 8 ".....	20c
Leather Lined Wood, 6 inch.....	6c
Leather Lined Wood, 7 inch.....	10c
Leather Lined Wood, 8 inch.....	12c
Leather Lined Wood, 9 inch.....	15c

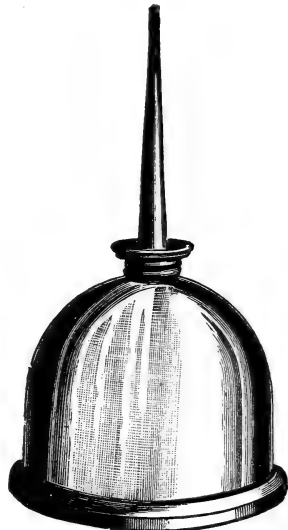

Monkey Wrenches, 6 in.	Coe's. Agric'l. \$ .45	30c
" " 8 in.	.50	35c
" " 10 in.	\$. 70	40c
" " 12 in.	.85	45c
" " 15 in.	1.35	

## OUR STANDARD VISE

Not a cheap one, but a strong, well-made vise.

No. 63 and 64 - - - - -	\$1.50
" 65 - - - - -	2.50
" 67 - - - - -	4.00
" 87 - - - - -	2.60
" 88 - - - - -	3.40
" 89 - - - - -	4.50
" 90 - - - - -	5.00

Nail Hammers, cast,	Coe's. Agric'l. 25c
" " steel,	35c and 50c
" " Maydole,	65c
Riveting "	50c
Tack "	10c and 25c
Cold Chisels, each.....	15c
" " (heavy) each.....	25c
Rivet Punches.....	15c and 20c

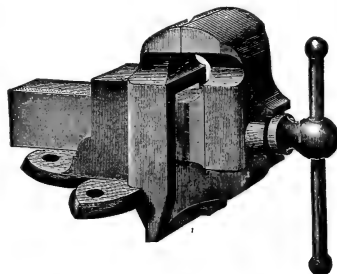

**HAY CAPS—Canvas or Fibre**  
Prices given on application.

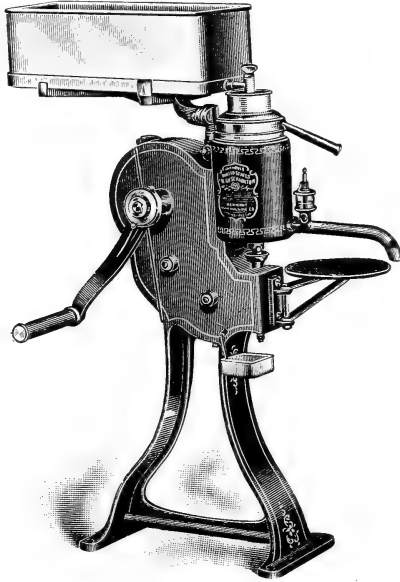

## NEW UNITED STATES CREAM SEPARATOR

Improved again, a still better machine Low Frame, New Ratchet, Open Frame at base, Easy Running, Easy Washing, Great Capacity.

Junior Style			Price.
No. 9.	Guar. Cap'ty per hr.	175 lbs.,	\$45.00
No. 8.	" "	300 "	60.00
No. 7.	" "	400 "	70.00
No. 6.	" "	500 "	75.00
No. 5.	" "	675 "	90.00
Interlocking Style (Latest).			
No. 17	Guaranteed Capacity	450 lbs.	\$75.00
" 16	" "	600 "	85.00
" 15	" "	750 "	95.00
" 14	" "	950 "	110.00

## CHAIN HANGING CATTLE STANCHIONS

The best and easiest method for fastening cattle in the stable.

We furnish these in either the Steel or Wood Head, and All Steel.

PRICE, Wood or Steel Head, \$1.35  
 " All Steel, 1.75

Special Price for Quantity.

### Chain Cattle Ties

Medium,	- - - - -	.30
Heavy,	- - - - -	.35
Very Heavy,	- - - - -	.75

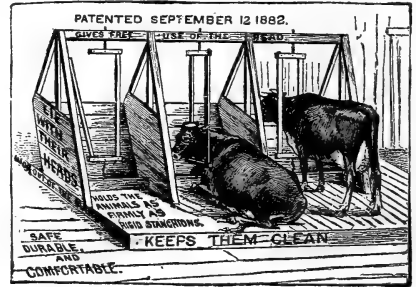

## DANA'S STOCK LABELS



An easy and practical way of marking Stock. Cattle labels may be marked with owner's name not exceeding 13 letters, and post office address, not exceeding 13 letters. Sheep label size has room for only 10 letters, Per doz. Per hun.

Cattle labels, lettered and numbered, .75 \$4.00  
 Sheep and hog labels, lettered and numbered, .40 2.00

PUNCHES—Cattle label size, Each 1.50  
 Sheep " " " 1.00

KEYSTONE IMPROVED DEHORNERS.—	Complete with leader and Extra Blades,	\$14.00
" " " "	Alone	12.00
" REGULAR " "	Complete	12.00
" " " "	Alone	10.00

# COOLEY CREAMERS

WITH ELEVATOR ATTACHMENT

TOO WELL KNOWN

TO NEED

EXPLANATION HERE

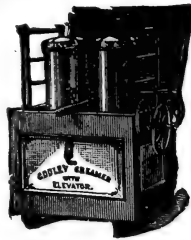

WRITE FOR SPECIAL

CIRCULAR AND

SPECIAL PRICES

No.	Cans	Cows	Dimensions	Height	Weight	Galvanized Castings
No. 00.	2 cans,	4 to 6 cows,	25 by 31 in.,	2 ft. 7 in. high.	243 lbs.,	\$ 32.00
No. 1.	Not manufactured.					
No. 2.	4 cans,	9 to 12 cows,	31 by 37 in.,	" "	"	45.00
No. 3.	6 "	12 to 18 "	31 by 49 in.,	" "	"	57.00
No. 4.	8 "	18 to 24 "	31 by 63 in.,	" "	"	68.00
No. 5.	10 "	24 to 33 "	31 by 76 in.,	" "	"	79.00
No. 6.	12 "	30 to 36 "	31 by 94 in.,	" "	"	93.00
No. 7.	14 "	36 to 42 "	31 by 109 in.,	" "	"	105.00
No. 8.	16 "	42 to 48 "	31 by 122 in.,	" "	"	117.00

Prices on CABINET CREAMERS on application.

## COOLEY

### CREAMER CANS

PRICE,

with cover and siphon faucet,  
\$2.70 each.



COOLEY CAN.

### REED CREAM CANS

with cover and faucet,

20 qt.,	\$1.50, \$1.65, \$1.75
16 qt.,	1.40, 1.50
20 qt., without faucet or glass,	\$1.25

### CREAM PAILS

With ventilated top, 20 qt., \$1.25  
" " " 24 qt., 1.50

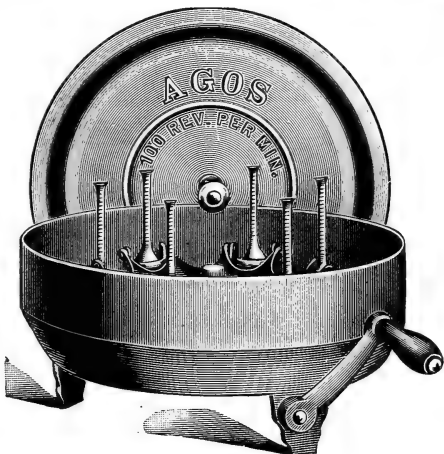

BABCOCK TESTER.

### Power—Dog, Sheep or Goat,—

Single power with regular pulley, 21 inch,	\$18.50
Double power with regular pulley, 21 inch,	\$25.00
Clutch Pulley on Separator extra,	\$3.50

### AGOS BABCOCK TESTER

THE LATEST AND BEST

Cast Iron Body and Cover, Spur and Spiral Gearing, Machine Cut Teeth.

PRICES—4 Bottle.....	\$8.00
6 ".....	9.00
8 ".....	10.00
10 ".....	12.00
12 ".....	14.00

# BLANCHARD CHURN

Probably the Best Crank  
Churn in Use

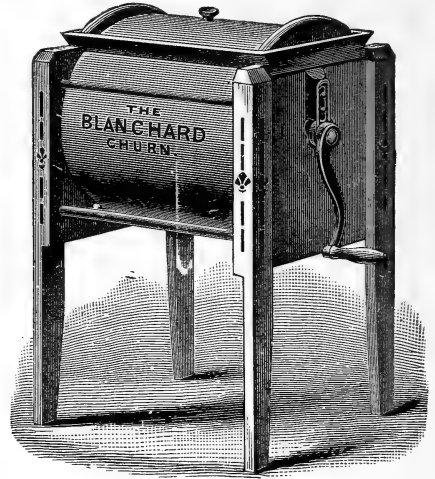

	List.	Net.
No. 3 Churns up to 2 gals.,	\$6.00	\$5.00
No. 4 " " 4 gals.,	7.00	6.00
No. 5 " " 8 gals.,	8.00	7.00

SEPARATORS.—See page 42.

## CYLINDER CHURN A Good Low Price Churn

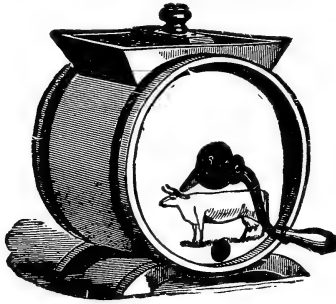

	List.	Net
No. 1.....	\$2.50	\$2.00
No. 2.....	3.00	2.50
No. 3.....	3.50	3.00
No. 4.....	4.00	3.25
No. 5.....	5.00	3.75

## DAVIS SWING CHURN

Easy to Operate.

Easy to Clean.

No Floats nor Paddles.

One of the Best Churns Made.

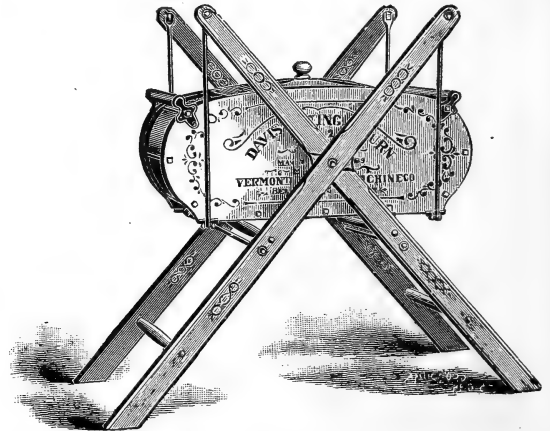

Size.	Capacity.	Will Churn	Price.	Extra for Iron Y and Pitman
No. 1	8 gal.,	4 gal. or less,	\$8.00	\$ .75
No. 2	10 "	5 " " "	9.00	.75
No. 3	16 "	8 " " "	10.00	.75
No. 4	20 "	10 " " "	12.00	.75
No. 5	26 "	13 " " "	15.00	1.00
No. 6	34 "	17 " " "	18.00	1.00
No. 7	60 "	30 " " "	25.00	1.25
No. 8	80 "	40 " " "	30.00	1.50
No. 9	100 "	50 " " "	35.00	1.75

There is less liability of getting churns too large than to small. Be sure and order churns large enough. There must be room in the churn to produce the concussion, and a small churn filled too full will require a longer time for churning.



# The Surprise Churn

Easy to Operate.

Easy to Clean.

No Floats nor Paddles.

The cover fastenings never give way and let the head out. Iron parts galvanized.

			Price.
No. 1	Churns from 1 to 4 gals.		\$9.00
No. 2	" " 2 " 7 "		10.00
No. 3	" " 3 " 9 "		12.00
No. 4	" " 4 " 12 "		14.00
No. 5	" " 5 " 16 "		17.00
No. 5½	" " 5 " 20 "		21.00
No. 6	" " 6 " 28 "		23.00



If you keep cows see us about the United States Cream Separator.

## WATER'S BUTTER WORKER

Tray Removable, Takes Place of Butter Bowl

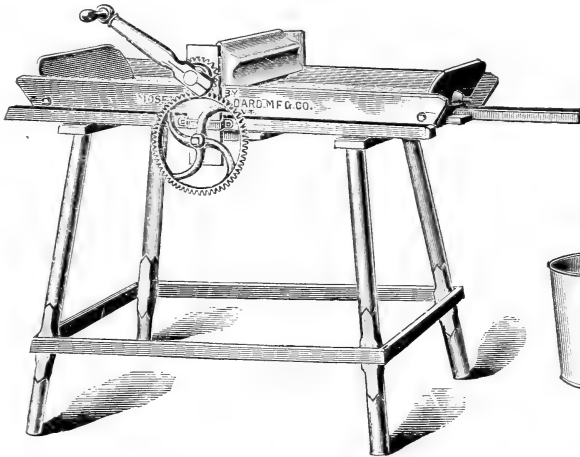

Size.	Length of Tray.	Width of Tray.	Capacity.	No. of Cows.	Price.
0	27 in.	14 in.	1 to 15 lbs.	1 to 4	\$ 7.00
1	36 in.	15 in.	5 to 30 lbs.	4 to 8	8.00
2	36 in.	18 in.	5 to 40 lbs.	8 to 12	9.00
3	39 in.	20 in.	5 to 50 lbs.	12 to 18	10.00
4	48 in.	22 in.	10 to 75 lbs.	18 to 30	12.00

## "Wyandotte" Dairymen's Cleaner and Cleanser

A Splendid Washing Powder for all milk and dairy utensils.

280 lb. Barrel,	\$ 8.40
80 " Keg,	3.20
5 " Sack,	.25

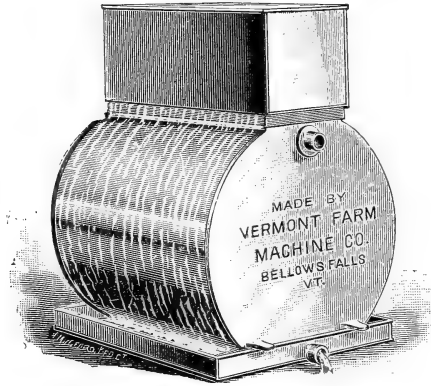

# “ARCTIC” Milk Cooler

This Cooler is arranged to be used either with ice, running water, or water pumped from well.

No. 1.	For 1 to 10 Cows,	Price,	\$6.50
No. 2.	“ 10 to 25 “ “	“	7.00
No. 3.	“ 25 to 50 “ “	“	8.00

## Reid's Butter Shipping Box

Capacity.	Price.
12 lb. Prints.....	\$3.50
20 “ “ .....	3.75
30 “ “ .....	4.25
40 “ “ .....	4.75
56 “ “ .....	5.00
80 “ “ .....	5.50
96 “ “ .....	6.00
120 “ “ .....	6.50
24 half lb. Prints.....	4.00
36 “ “ .....	4.50
64 “ “ .....	5.25
80 “ “ .....	5.50
100 “ “ .....	6.00
120 “ “ .....	6.50
140 “ “ .....	7.00

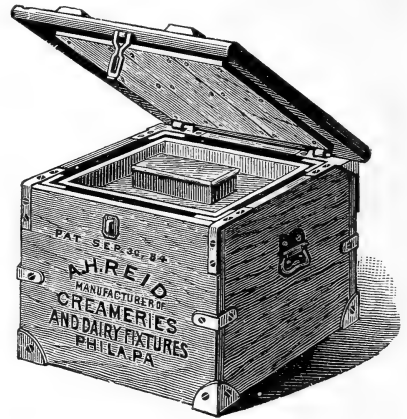

## SALT

“Retsof” Lump Salt.....	per lb.	\$ .01
“ “ “ .....	per ton,	15.00
No. 2, “Retsof” (best for ice cream, etc.).....	per bag, 200 lbs.	1.00
Cattle Salt, (coarse fine) .....	per 160 lb. bag,	1.00
Cattle Salt, (coarse fine) .....	per 56 lb. bag,	.45
Dairy Salt, (High Grade) .....	per 56 lb. bag,	.55
Dairy Salt, Purity .....	per 56 lb. bag,	.70
Dairy Salt, Worcester .....	per 56 lb. bag,	.85
Turk's Island Meat Salt.....	1 bushel sack	.75
Turk's Island Meat Salt.....	2 bushel sack,	1.25
Roto Salt Holder.—35c. each.		
“ “ Cake.—15c each,	\$1.50 per doz.	
Square “ “	25c each.	

## Thatcher's

### Orange Butter Color

Small Bottles.....	\$ .25
Large Bottles.....	.50
One Quart Cans.....	1.00

Use Atlas Cement for your stable floor and for concrete work about the barns.



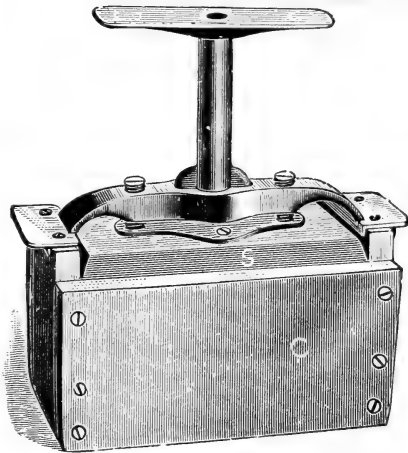

No. 2 BUTTER MOULD.

## Butter Moulds

No. 2 Mould, Price 1 lb., \$2.00; 2 lb., \$2.25  
 Daisy Mould, Price 1 lb., \$1.25; ½ lb., \$1.00  
 Common sense Mould, 1 lb., 90c  
 Individual, 10c  
 CARVING.—Any name, monogram or design carved on moulds to order.

Anderson Butter Ladles, Price 15c  
 Flat Butter Spades, plain, " 10c  
 Concave Butter Spades, plain, " 15c  
 Butter Spades, creased, Price 10c and 15c  
 Milk Measures, One Quart Graduated, 25c.  
 " " Two " " 35c.  
 " Dippers, 35c.

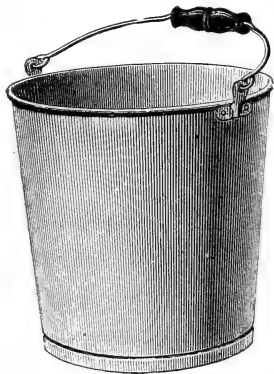

Central Strainer Pail—detachable strainer, heavy, \$1.25  
 Patent Strainer Pail—Heavy detachable, 3-ply strainer, 1.50  
 Heavy Tin Milk Pail—14 quarts, .50  
 " " " 12 " .45  
 Common Strainer Pails, 75c and 1.00  
 Hygienic Milk Pail, 1.75

## Galvanized Iron Pails

10 Quart, heavy, \$ .25  
 12 Quart, heavy, .35  
 14 Quart, medium, .30  
 14 Quart, heavy, .40  
 14 Quart, extra heavy, .60

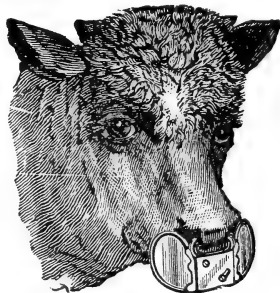
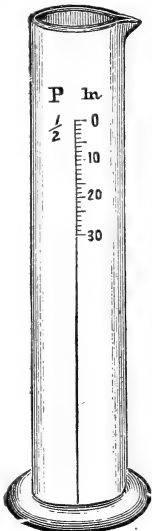
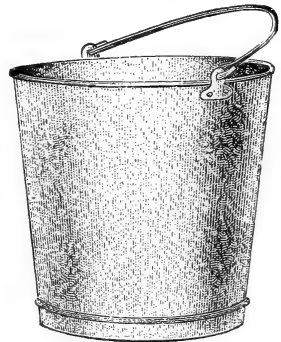

## Weather Vanes

Special Illustrated Sheet of Designs and Prices Sent on Application.

## Cream Gauge

For determining the per cent. of Cream in Milk, 85c

## MILKING TUBES

Coin Silver, price 60c.  
 Plated, 20, 25, 30 and 35c.  
 Teat Dilators each 30c, set of 4 \$1.00.

CATTLE LEADERS, 15c.  
 OX BOW PINS, 20c Per Pair.  
 CATTLE CARDS, Common Size 10c, large size 15c.  
 COW BELLS, No. 3, 25c; No. 2, 30c; No. 1, 35c.  
 WEANERS, Small, Calves, 40c; Medium, Yearlings, 50c; Large, Cow, 65c.  
 TALL PATTERN OX BUTTON, 20c Per Pair.  
 OX MUZZLES, heavy, 40c Per Pair.  
 BULL RINGS, Copper, Medium, 30c: Copper, Large, 35; Cannon Metal, very heavy, \$1.50. PUNCH, 75c.  
 BULL STAFF, Light, \$1.00; Best Heavy Brass, \$3.00.  
 RUBBER APRONS, Heavy, \$1.75 and \$2.25  
 RUBBER MOP OR SQUILGEE, 75c and \$1.00.  
 WOOD STABLE FORK (best), 75c.

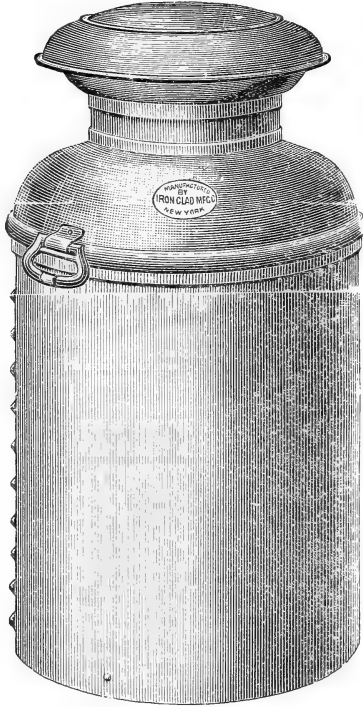

**"IRON CLAD"  
RAILROAD MILK CANS  
NEW YORK PATTERN**

20 Quart.....	\$3.50
30 ".....	3.75
40 ".....	4.00

Special price to milk dealers using quantities.  
Goods Marked "Iron Clad" are the Very Best Quality Made.



SPECIAL ATTENTION is given to supplying Combination Shipping Cans for milk butter, eggs, cream.

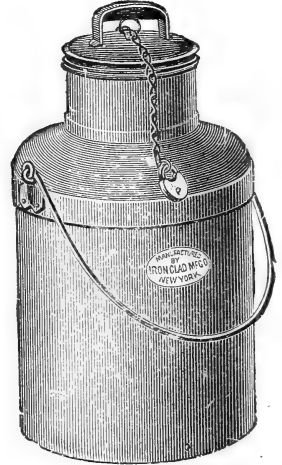

SPECIAL DELIVERY

**"IRON CLAD" RAILROAD MILK CANS**

SPECIAL DELIVERY PATTERN

10 Quart, plain.....	\$3.00	16 Quart, plain.....	\$3.50
12 " ".....	3.25	20 " ".....	4.00

CHAIN AND PADLOCK EXTRA

Extra for Cream Compartment.....	\$1.00
" Butter ".....	1.00
" Marking " each plate.....	.25

Prices on other Styles Special Delivery Cans on Application



BOSTON PATTERN

**"IRON CLAD"**

City Delivery

Milk Cans

Either Jug Handle or Bail.

1 Quart, Boston Pattern, .60
2 " " " .75
4 " " " .90
6 " " " 1.15
8 " " " 1.35
10 " " " or Providence

Pattern, 1.70

**Boston Milk Can, City Delivery Pattern**

Quarts.....	1	2	3	4	6	8	10
Price 1X.....	.35c	40c	50c	60c	70c	85c	\$1.00
" 1C.....	.15c	20c	25c	30c			

**Milk Pans**

Heavy Tin

	Each.	Per Dozen.
6 Quart,	.15	\$1.75
8 " "	.18	2.00
10 " "	.20	2.25
12 " "	.25	2.50

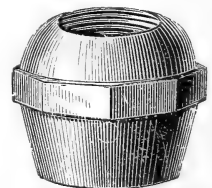

Octagon Ox Button, 10c per pair.

**SPECIAL MILK STRAINER**

An excellent strainer, in fact the best and easiest to keep clean that we have found. Price, Medium size, \$1.00; Large size, \$1.25.

COMMON STRAINER .....50c

**WOOD BUTTER BOWLS**

Best Quality, 13 inch.....Price \$ .25  
 " " 15 " ..... " .40  
 " " 17 " ..... " .65  
 " " 19 " ..... " .85  
 " " 21 " ..... " 1.00

OBLONG WOOD BOWL, medium size, 40c; large size, 45c.

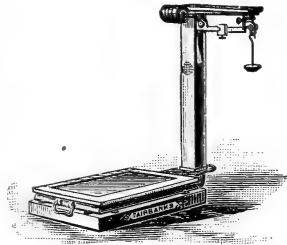

**PLATFORM SCALE**

Capacity 600 lbs., with wheels. Prices from \$10.00 up.

**FAMILY OR DAIRY SCALE**

Capacity, 1/2 oz. to 240 lbs. positively accurate, with platform and scoop,

Price, \$4.00

Without platform, capacity 1/4 oz., to 25 lbs.,

Price, \$3.50

Ice Scales, Chatillons, weighs from 5 lbs. to 200 lbs., Price, \$3.00

Steelyards, 1 oz. to 50 lbs.,

Price, \$75



**DIAL SCALE**

Weights up to 25 lbs., enameled top, \$1.00 and 1.25

Special Milk Scale weighs 30 lbs.

by ounces, - - - - \$3.50

Special Milk Scale weighs 60 lbs.

by 2 ounces, - - - - 4.00

Special Milk Scale weighs 60 lbs.

by tenths, - - - - 4.50

Scale Beams, heavy Japanned. 300 lbs. capacity, \$2.25; 400 lbs. capacity, \$2.50; 500 lbs. capacity, \$2.80.

**SCALES**

If you contemplate putting in what is termed Hay Scales, we would be pleased to give you an estimate.

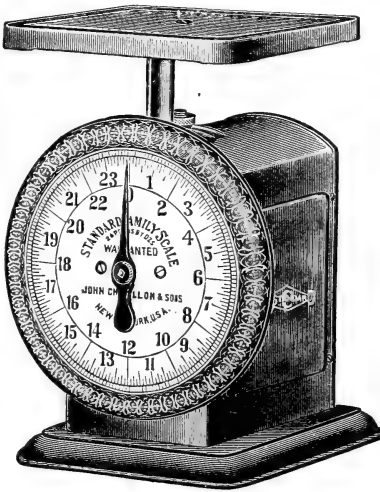
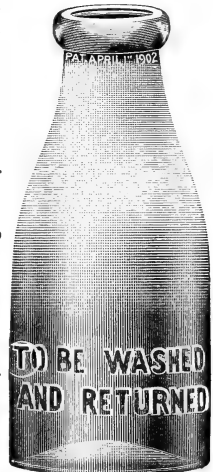

**Parchment Butter Paper** — PURELY VEGETABLE

Stock Sizes—7x9, 8x11, 8x12, 9x12,—other sizes to order. Price per lb., 20c. Price per 5 lbs., 90c.

**Common Sense Milk Bottles**

Quarts, 10c each, \$1.00 doz; Pints, 8c. each, 90c. doz. Caps for same, per M 50c.

Special Prices on large quantities.

The use of these Bottles insures the neat delivery of milk and cream.

**Wire Carrying Baskets**

For delivering milk in bottles, 4 bottle size, 75c, 6 bottle size, \$1.00.



DAIRY FLOATING THERMOMETER.....Price 25c and 75c



**RUBEROID ROOFING**,—Water-proof, Heat Proof, Vermin Proof, Air Tight, Tasteless and Oderless, will not run, melt or rot. Any handy man can apply it.

**Prices in Full Rolls**

½ Ply, per square or 100 square feet, \$1.75.  
 1 Ply, per square or 100 square feet, \$2.25.  
 2 Ply, per square or 100 square feet, \$3.25.

<b>RUBERINE</b> ,—	Black.	Brown or Red.	Green.
½ Gal. Can, . . . . .	.50	.75	.90
1 " " . . . . .	.90	1.20	1.60
2½ " " Per Gal., . . . . .	.80	1.10	1.55
5 " " " " . . . . .	.75	1.05	1.50

**TARRED PAPER**,—

Single ply, per roll of 320 square feet (about 40 lbs.), 3c. lb.  
 Two ply, per roll of 108 square feet, \$1.00.  
 Three ply, per roll of 108 square feet, \$1.25.

**AMATITE ROOFING**,—An excellent roofing material, made of several layers of water-proof material and pitch, with a layer of gravel on one side. Per roll of 108 sq. ft., \$2.25. Special prices on large quantities.

**RUBERCOAT ROOF PAINT**, per gal., \$.75.

## “Lenox” Horse and Cattle Remedies

These remedies are very reliable, and a supply should be kept on hand in every Horse or Cow Stable. They are Medicines not Feeds.

<b>ACCLIMATINE</b> —For Epizootic and Colds, especially good for horses from the West	75c
<b>LENOX LINIMENT</b> —The Universal Embrocation, - - - - -	50c
“ <b>TONIC</b> —And Condition Powders, - - - - -	50c
“ <b>WORM POWDERS</b> —For Horses, - - - - -	50c
“ <b>LIQUID BLISTER</b> — - - - -	50c
“ <b>RED LOTION</b> —For Wounds - - - - -	50c
“ <b>COLIC CURE</b> —For Horses, quick acting, keep on hand, - - - - -	50c
“ <b>MANGE REMEDY</b> —For Horses, Dogs and Cats, - - - - -	50c
“ <b>GOLDEN PRECIPITATE</b> —For Thrush, positive cure, - - - - -	50c
“ <b>GALL CURE</b> —The very best yet, - - - - -	25c
“ <b>PREVENTATIVE FOR MILK FEVER</b> —For Cows, especially good, - - - - -	25c

## NUTRIOTONE

A first-class Medicinal Food for Horses and Cattle.

2 lb. package, - - - - -	\$ .50
5 lb. package, - - - - -	1.00
25 lb. pail, - - - - -	4.00
<b>RUST'S HAVEN'S CLIMAX CONDITION POWDERS</b> ,—13 oz. pkg. 25c. 32 oz. pkg. 50c.	
5 lb. pkg. \$1.00.	

## Blatchford's Calf Meal

25 lb. Bag, - - - - -	\$1.00	50 lb. Bag, - - - - -	\$2.00
<b>CALF CORDIAL</b> , - - - - -		pkg. 50c	

## UNITED BREEDERS STOCK FOOD

This Food is Very Much Liked Both for Horses and Cattle

25 lb. box.....	\$2.75
50 lb. box.....	5.00
100 lb. drum.....	9.50
200 lb. drum.....	18.00

### International Stock Food

This food, we find gives excellent satisfaction.

Price per small package.....	\$ .25
"    medium    ".....	.50
"    large    ".....	1.00
"    pail (25 lbs.).....	3.50
International Heave Cure.....	.50

**WHITE ROCK HOOF PACKING.**—An excellent article.

Small size.....	\$ .25
Medium.....	.50
Large.....	1.00

**KOWKURE.**—A medicine for cows only. Prices, small can, 50c; large can, \$1.00

**GRANGE GARGET CURE.**—For the cure of milk fever and garget. Price.....50

**PRATT'S ANIMAL REGULATOR,** very reliable, per pkg.....50

**COMMON SENSE CALF FEEDER**.....\$2.00

**SMALL'S CALF FEEDERS**.....\$2.50  
Nipples, each.....25

**SILVER PINE HEALING OIL.**—  
Per bottle.....50

**REFINED PINE TAR.**—Per can .10 and .20

**COAL TAR.**—Pt. can 15c, qt. 30c, gal. 55c

### CHAINS

**STAKE.**—Heavy, short link, per pair.....70c, 90c, \$1.20

**SHORT TRACE.**—Medium, per pair .35  
" " " " Very heavy, " .40

**LONG** " " " .70

**LOG OR STONE CHAIN.**—

3/8 in. x 12 ft., 1 grab hook, 1 common hook.....\$2.25

7-16 in. x 12 ft., 1 grab hook, 1 common hook.....\$2.75

7-16 in. x 14 ft., 1 grab hook, 1 common hook.....\$3.00

1/2 in. x 14 ft., 1 grab hook, 1 common hook.....3.75

**LOG CHAIN.**—

3/8 in. x 12 ft., hook and ring.....2.00

7-16 in. x 12 ft., " " ".....2.50

7-16 in. x 14 ft., " " ".....2.75

1/2 in. x 14 ft., " " ".....3.25

**STONE BOAT, OR DRAG.**—Prices from.....\$5.00 to \$8.00

**STEEL CROW BARS.**—Per lb......07

**STONE BOAT FRONT.**—Heavy iron, used with straight plank.....2.85

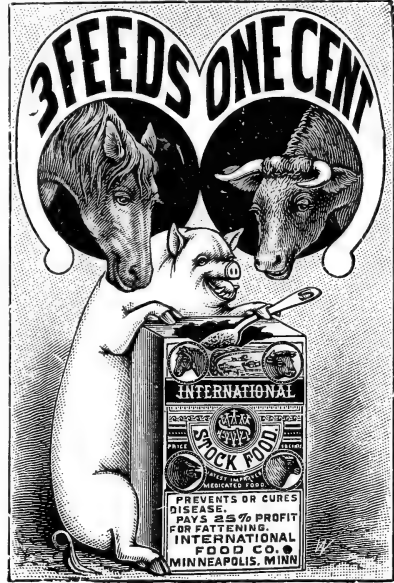

### Whiffletrees, Eveners, Neck Yokes

These we have made for us out of first-class timber, and the trimmings are of forged steel.

**NECK YOKES.**—Short, each.....\$1.25  
" " " " Long, ".....2.50

**EVENERS.**—Medium.....2.00  
" " " " Extra heavy.....2.50

**WHIFFLETREES.**—Medium, each.....1.00  
" " " " Extra heavy, each 1.25

**EVENERS AND WHIFFLETREES.**—  
Per set.....\$4.00 to \$5.00

**EVENERS.**—Factory made.....1.25  
**WHIFFLETREES** "......75

### CANT, OR LOG HOOKS

Vermont Pattern, light.....\$1.25  
" " " " heavy.....1.50

Maine " " ".....1.50  
**TIMBER CARRIERS.**—Each.....1.50

**SPLITTING WEDGES.**—  
Sq. head, per lb......06

**SPLITTING WEDGES.**—  
Round head, per lb......07

**WOODCHOPPERS' MAUL.**—  
Steel, per lb......12

**SLEDGES.**—Steel, per lb......15  
**STONE HAMMER** "......15

**HAND** " "......20  
" " " " "......20

**DRILLS** " "......20  
**WEDGES AND SHIMS.**—Per lb......20

**STONE CUTTERS' POINTS.**—Per lb.....15

## THE CYPHERS' 1910 INCUBATORS

### WORLD'S STANDARD HATCHERS

The Cypher Incubators are without doubt the most practical and best hatchers made today. The Cyphers Incubators and brooders, are insurable and bear the label of the "Underwriters Laboratories."

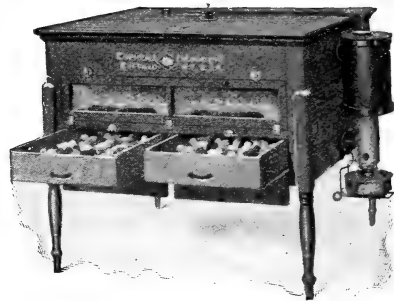

Be sure you get the Label.

### PRICE LIST

No. 0.	70 Hen Eggs	56 Duck Eggs,	-	-	-	-	-	-	-	-	\$15.00
No. 1.	144 "	112 "	"	"	-	-	-	-	-	-	22.00
No. 2.	244 "	200 "	"	"	-	-	-	-	-	-	32.00
No. 3.	390 "	300 "	"	"	-	-	-	-	-	-	38.00

Ask or send for Special Cyphers' Catalog.

### THE CYPHERS' 1910 INSURABLE BROODERS

Style A. (formerly known as Storm King) equipped with Adaptable Hover, and bearing Underwriters' Label. Price complete, \$12.50.

Style B. Three apartment, Brooder and Colony Roosting Coop, with adaptable Hover and bearing Underwriters' Label. Price complete, \$16.50.

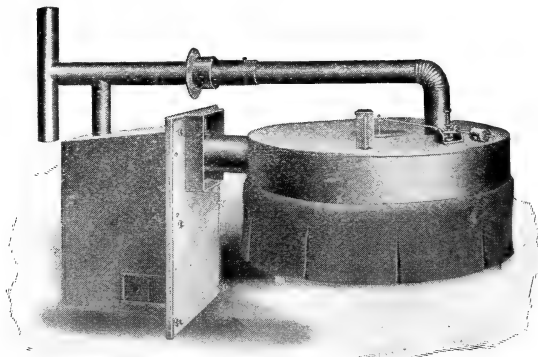
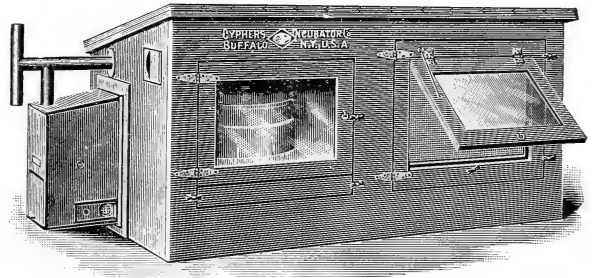

**Adaptable Hover.** Self-Regulating, Self-Ventilating complete with Regulator and Thermometer and bearing Underwriters' Label, \$8.50.

Style A, 1908 Brooder,	\$15.00
Storm King, 1908 "	10.00
Colony House, 1908,	18.00

Insulated Brooder Stove (1908 pattern), - - - - - \$1.50



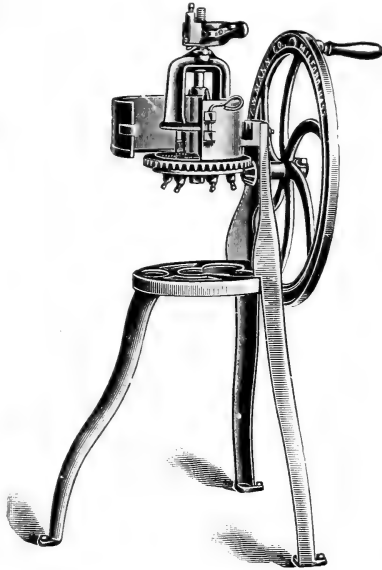

MANN'S BONE CUTTER

**Chicken Feed Cutter**

Cuts 1-4, 7-16, 3-4 inches.

Has three 6 1/4 inch knives and is a rapid cutter, - - - - - Price \$15.00

**Nest Eggs**

China, per dozen, - - - - - .30  
Wooden, " - - - - - .30

**Adjustable, Climax or Eclipse**

**Leg Bands**

Per dozen, 20c, - - - Per 100, \$1.00  
Poultry Punches, - - - 25c and 50c

**Egg Testers**

Each, - - - - - 25c and 50c

**SHERIDAN'S CONDITION POWDERS,—An Egg Producer of merit.**

Used in connection with B. B. B. it has shown wonderful results.

Small Package, 20c. 2 1/2 lb. Can, \$1.00. 6 Cans for \$5.00

**SANITARY SELF FEEDING BOX for feeding shells, grit, bone, etc.**

Made of Heavy Galvanized Iron. Price 50c.

**DRY FEED HOPPER, 75c.**

WIRE HEN'S NESTS each 15c. Per doz., \$1.50

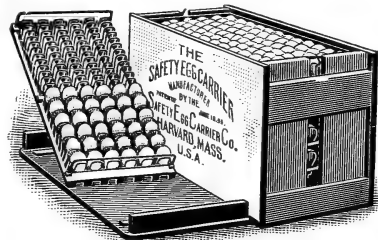

**The MANN BONE CUTTER**

For Grinding Green or Dry Bone  
An Excellent Machine.

		Our Price.
No. 5-C.	With crank,	\$6.00
No. 5-B.	" balance wheel,	8.00
No. 5-B-M.	" " " and stand	10.40
No. 7-B.	" " " "	12.00
No. 7 1/2.	Semi-Power,	16.00
No. 9.	With bal. wheel and stand	18.40
No. 11.	Power Machine,	26.00

**Pratt's Poultry Food**

26 oz. Package, - - - - -	.25
5 lb. Package, - - - - -	.60
12 lb. Package - - - - -	1.25

**Baum's Poultry Food**

An excellent article, Pkg., 25c and 50c

**Howard & Morrow's Roup Remedy**

A medicine of merit, Per box 50



**Roup Pills (Rust's Havens)**

Per Box, - - - - - 25c

**Conkey's Roup Cure**

Per Box, - - - - - 25c and 50c  
Conkey's Cholera Cure, - - - - - 50c  
" Gape " - - - - - 50c



**EGG CARRIERS**

30 Dozen Trays and Cases Combined	\$3.25
24 " " " " " "	3.00
16 " " " " " "	2.50
9 " " " " " "	2.25
6 " " " " " "	1.75

Trays only for 6 and 9 doz. carriers, each .45  
" " " 16 " " " .50



**DEATH TO LICE POWDER**

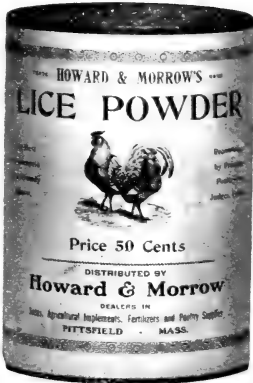

This was first recommended to us by local poultrymen, and has given excellent satisfaction, doing perfectly the work intended.

- Small Package.....\$ .25
- Medium "....." .50
- Large "....." 1.00

**LIQUID LICE KILLER**

This is a liquid insecticide for destroying lice on poultry, stock, etc., and is an excellent article, very easy to use, and does its work thoroughly. It is also a disinfectant

- Price 1 Quart Can.....\$ .35
- " 2 " "....." .60
- " 4 " "....." 1.00

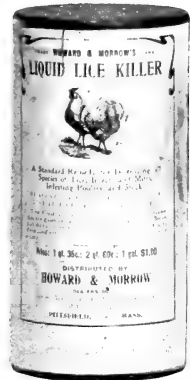

**SULPHUR FUMIGAT'G CANDLES**  
Each 15c.

**The "Sanitary" Poultry Fountain**

Can be thoroughly and quickly cleansd. Cheap, neat and durable. Made of heavy galvanized iron.

Price, 1 gallon 65c. 2 gallon, \$1.00.

HEATER for 1 gal. Fountain, 60c. For 2 gal. Fountain, 75c

**Cyphers Poultry Fountain**

- 18c
- 75c
- 35c
- HEN FRIEND POULTRY FOUNTAIN, 30c, 50c and 75c.
- PEERLESS POULTRY FOUNTAIN, 80c.



**Earthen Poultry Fountain**

**VERY MUCH IMPROVED.**

Saucer detachable; very easily cleaned; 2 qt., 35c each; 4 qt., 50c each.

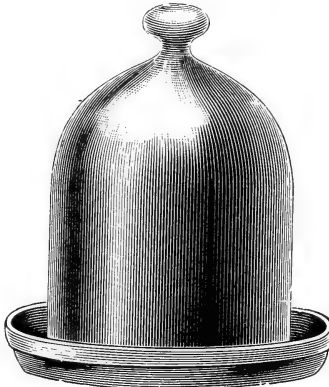

EARTHEN POULTRY FOUNTAIN

**SNOW SHOVELS**

- Boys' 7x10 inch iron tip.....15c
- " Rural 11x14 inch Sheet iron tip, 25c
- Rural 14x20 " ".....35c
- " 16x20 " ".....40c
- " 18x20 " ".....45c
- Cole, 16x20 " Steel edge tip, 45c
- " 18x20 " ".....50c
- All Steel.....50c
- Galvanized Iron (new).....75c
- Sidewalk Chisels (Socket Forged) 50c & 75c

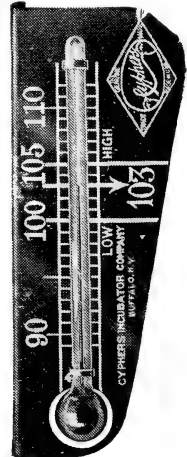
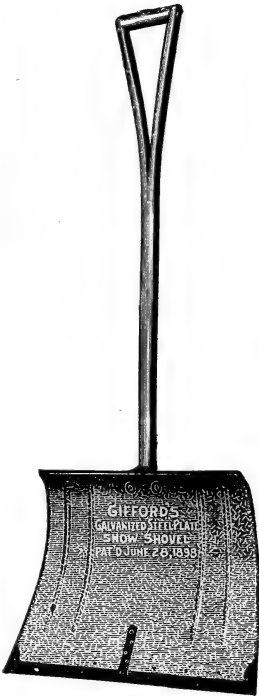

STANDARD

Incubator  
Thermometer

Price 65c.

Cyphers' Brooder Thermometer for A Brooder, - - - - - 50 Cents

# Galvanized Poultry Netting

WE HANDLE THE BEST MAKE OF NETTING

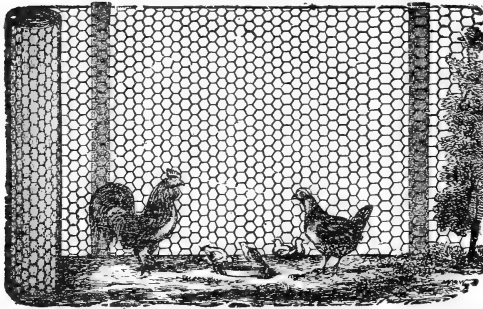

POULTRY NETTING STAPLES—Per lb. package, - - - - - 10c

### STOCK WIDTHS.

1 ft. 2 in. mesh	3 ft. 2 in. mesh
1½ ft. 2 in. "	4 ft. 2 in. "
2 ft. 2 in. "	5 ft. 2 in. "
2½ ft. 2 in. "	6 ft. 2 in. "
Price in full rolls, per 100 sq. ft., 60c	
Less than full rolls, per sq. ft., ¾c	
1 ft. 1 in. mesh	2½ ft. 1 in. mesh
1½ ft. 1 in. "	3 ft. 1 in. "
2 ft. 1 in. "	4 ft. 1 in. "
Prices in full rolls of 150 feet in length,	
per square foot, . . . . . 1¼c	
Less than full rolls, per square ft. 1½c	

# American Field Fencing

The best fencing made for stock of any kind. It is strong, neat and safe; will stop anything from a pig to a buffalo.

Made in widths from 22½ inches to 58 inches. Stock numbers are 845-12, 635-12 and 832-6.

Stock numbers on Poultry and Rabbit fence are 2158-6.

Prices on Application.

Send for our Special Fence Book, which will tell you all about the fence and the Yankee Gates.

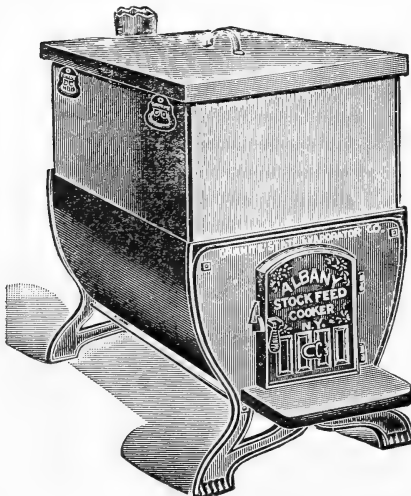
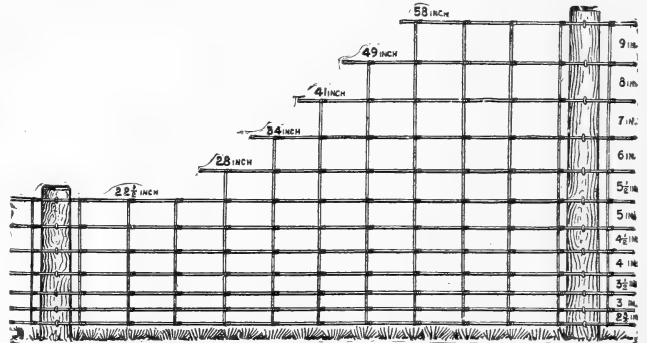

## ALBANY Stock Food Cooker

This cooker is made to meet the popular demand for a good cooker at a low price. The boiler is made of galvanized steel, with cover of same. A joint of 6 in. pipe and elbow furnished with each Cooker.

Price, 25 gallon. . . . . \$ 7.50  
 " 50 " . . . . . 10.00

## FARMER'S BOILERS

(Prices subject to change.)

	For Wood.	For Coal.
15 Gallon . . . . .	\$13.00	
20 " . . . . .	14.00	\$17.00
25 " . . . . .	18.00	
30 " . . . . .	22.00	26.00
40 " . . . . .	27.00	33.50
50 " . . . . .	33.00	39.00
65 " . . . . .	39.00	43.00

Special Boiler, holds 55 Gals., thoroughly practical, price. . . . . \$15.00



The above is cut of 2 point Barb-Wire. This is the style of barb-wire now in general use. In figuring estimate about 15 ft. to lb.



**PLAIN 2-PLY FENCE WIRE.**—This is safer than the barb wire for horse pasture, it also makes a neat lawn fencing. If the end posts are firmly set so that they do not give, it will never sag. We are always in a position to name you **Low Prices** on first-class steel fence wire. The price per lb. on each of the above wires will be the same.

**ANCHOR FENCE POSTS.**—Suitable for either wire or netting.

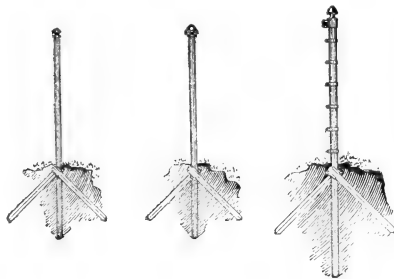

No. 2                      No. 3                      No. 4

No. 2 is the Standard Post, made of U-shaped galvanized steel.

Price without Top.....	HEIGHT ABOVE GROUND.			
	3 ft. 6 in.	4 ft.	4 ft. 6 in.	5 ft.
.....	\$1.75	\$1.90	\$2.00	\$2.20
Price with Top.....	1.90	2.15	2.25	2.95
	3 ft. 6 in.	4 ft.	5 ft.	6 ft.
<b>END OR CORNER POST, No. 4.</b> —For top rail or pipe fence	\$4.20	\$4.40	\$8.25	10.20
<b>END OR CORNER POST, No. 6.</b> —Similar to No. 4—used on fences without top rail.				
<b>HITCHING POST, No. 3.</b> —Galvanized	\$2.85.			
<b>HITCHING POST, No. 3.</b> —With chain and snap,	\$3.25.			
<b>STANDARD STEEL FENCE POST.</b> —				

Line Posts, \$ .50 to \$ .80.  
 End " \$1.75 to \$2.75.  
 Corner " \$2.00 to \$3.75.

We can furnish Line Posts, End Posts, and Corner Posts, any length up to 8 feet above ground, and any strength desired. Prices on application.

**GIBBS Post Hole Digger.** The Best General Purpose Digger Made. Price \$1.75.

**Wire Fence Staples** for either round or flat wire, when sold with the wire same price per lb. as the wire.

**CAST IRON MAULS.**—Weight from 12 lbs. to 20 lbs., each. .... \$1.00

**TAMPERS.**—Either post or sod, each. 1.00

**AMERICAN FENCE STRETCHER,** 6.00

**"COME ALONG"**—Wire Stretcher, Price 50c

**LINEMAN'S PLIERS.**.....\$1.25

**POST HOLE SPOONS.**..... 1.75

**WIRE CUTTING PLIERS.**—Medium size 50c

" " " Large size, 75c

**FENCE** " \$1.25



## Patent Automatic Lock Tackle Block

[ THIS LOCK HOLDS THE LOAD ] AT ANY POINT

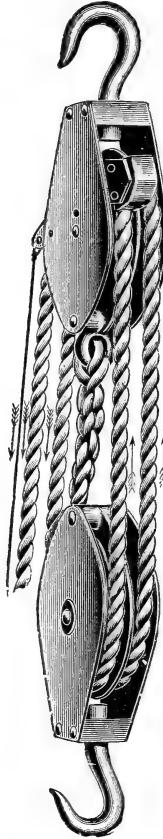

No.	No. of Sheaves.	Size Rope.	Lbs. one man can hoist.	Lbs. Capacity.	List. Price.
No. 8	2 and 1	3-8	300	600	\$3.00
No. 9	2 and 1	5-8	350	1000	5.50
No. 10	2 and 2	5-8	500	1500	6.00
No. 11	3 and 2	5-8	625	2000	6.80
No. 12	3 and 3	5-8	750	3000	7.60
No. 13	4 and 3	5-8	900	3500	8.35
No. 14	2 and 1	3-4	350	1250	6.50
No. 15	2 and 2	3-4	500	1800	7.00
No. 16	3 and 2	3-4	625	2500	8.00
No. 17	3 and 3	3-4	750	3700	9.00
No. 18	4 and 3	3-4	900	4000	10.00

BUTCHER KNIVES—5, 5½, 6, 7, 8, 9, 10, 12, 14. Prices—25c, 30c, 35c, 40c, 50c, 60c, 75c, 90c, \$1.25.

STICKING KNIVES—Warranted, 5 in. 30c, 6 in. 35c  
 COFFEE MILLS—.....50c, 75c, and \$1.50  
 APPLE PARERS—Hudson......75  
 POTATO SLICERS—.....1.00  
 CHOPPING KNIVES.....25c and 35c  
 HOG SCRAPERS—Each......15  
 “ Catchers, each......75  
 “ Rings, per 100......15  
 “ Ringers......25  
 REVOLVERS......75c to 6.50  
 CORK SCREWS......5c to .50  
 CORN POPPERS.....1 qt. 15c, 2 qt. 20c, 4 qt. .50  
 “ Sheet Iron, new......25



## THE UNIVERSAL FOOD CHOPPERS

Cuts all kinds of food into clean cut uniform pieces, either fine or coarse, as desired

Price No. 1.....\$ .90  
 Price No. 2.....1.25

### TABLE KNIVES AND FORKS.

Nice assortment, ranging in price from 75c to \$2.50 per set.

### POCKET KNIVES.

Complete stock of warranted knives

## RAZORS

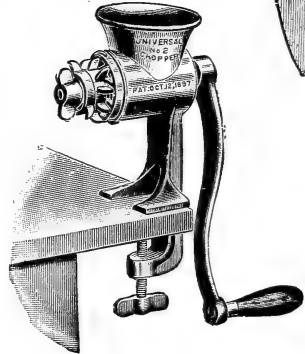
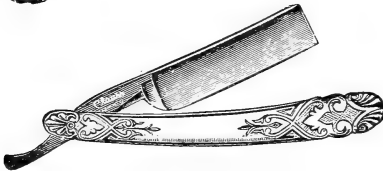

Our Special Brand of Razors are beauties and are splendid cutters. Prices from \$1.25 to \$3.00.

GILLETTE RAZOR—(12 extra blades) \$5.00  
 STAR SAFETY RAZOR— \$1.50 and upwards  
 EVER READY SAFETY— \$1.00  
 RAZOR STROPS— Swing from 25c to \$2.00  
 COMBINATION— 35c to \$2.50  
 LATHER BRUSHES—  
 15c, 25c, 50c, 65c, \$1.00 and \$1.50  
 SHAVING MUGS— 25c, 35c and 40c  
 RAZOR HONE— \$1.00  
 KITCHEN KNIVES— 10c, 15c 20c and 25c  
 DINNER PAILS—Common 30c  
 “ Heavy 30c  
 LUNCH BOXES  
 “ Folding 10c, 15c, 20c and 65c, 25c  
 TACKS—Gimp, Carpet and Double Pointed,  
 per pkt., 5c  
 TACK PULLS— 10c  
 BIRD GRAVEL—Per pkt. 10c  
 CUTTLE BONE—Each— 2c to 5c  
 FLOWER POT BRACKETS—  
 Single Pot Bracket, 25c  
 Two Pot Bracket, one arm, 40c  
 Two Pot Bracket, two arms, 45c  
 CARVING SETS—An assortment of warranted sets, prices from \$1.00 to \$10.00

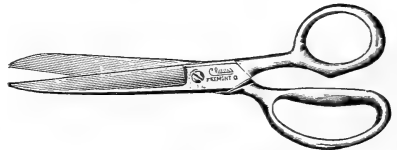

SCISSORS AND SHEARS—Our “Special” Scissors are “best goods”—we have a full line of these, also cheaper grades.  
 MOUSE TRAPS—Wood Chokers 5c and 10c  
 “ French Wire, 25c and 40c  
 RAT TRAPS—Erie, 15c and 25c  
 “ French Wire, 50c and 85c  
 GAME TRAPS— From 12c to 45c  
 COUNTER DUSTERS— 35c, 45c and 60c  
 WELL BUCKETS—Oak, plain hoop, 65c  
 “ galvanized hoop, 90c  
 FLOUR SIEVES— 20c, 25c and 30c  
 BRASS RINGS—For fancy work, per dozen 3c to 10c  
 HAMMOCK HOOKS—Per pair, 15c  
 BAIL OR BOX HOOKS—Each, 25c  
 BIRD CAGE HOOKS— 5c, 10c and 15c  
 SLAW CUTTERS—(2 knives), 30c and 50c  
 “ (3 knives), \$1.75 and \$2.25  
 “ 4 “ 3.00 “ 3.50

# OUR FARM WAGONS

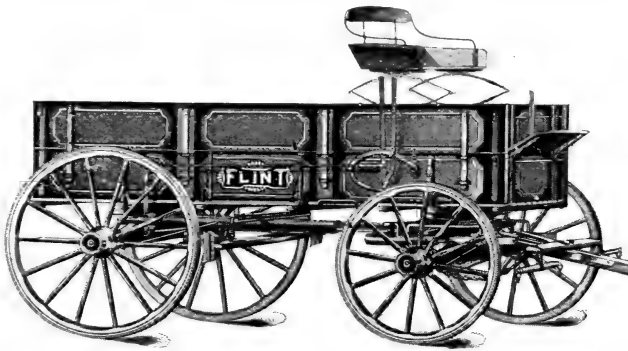

**The Lightest Running and Strongest Farm Wagons on Wheels.**  
 THOROUGHLY MADE THROUGHOUT, WELL FINISHED, FULLY  
 GUARANTEED, BROAD TIRES.

Style.	Size of Axle.	Kind of Wheels.	Size of Tire.	Price Gear Only.	Price Complete With Box, Top Box and Seat
Solid Axle,	1 3/4 in.	Sarven	3 x 1 1/2 in.	\$78.00	\$92.00
" "	1 7/8 "	" "	" " "	82.50	96.50
" "	2 "	" "	" " "	94.50	
Hollow Axle,	2 1/8 "	" "	" " "	73.00	\$7.50
" "	2 3/8 "	" "	" " "	78.00	92.50
" "	2 5/8 "	" "	" " "	82.50	96.50

Double Box, Complete with Spring Seat, \$20.00.

# ONE HORSE WAGONS

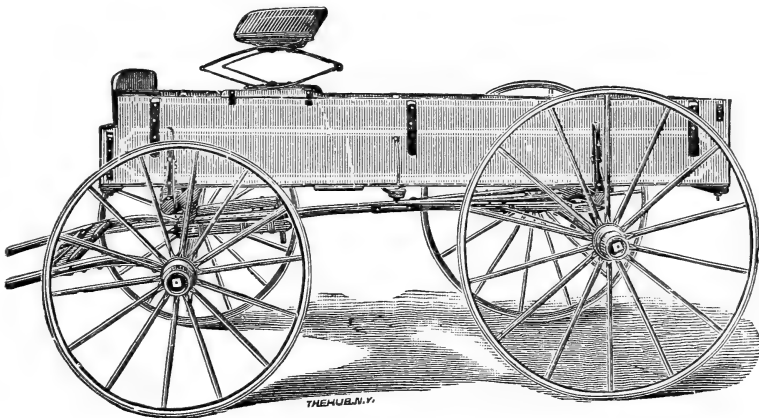

	Gear Only.	
1 1/4 in. Solid Steel Axles, Sarven Wheels, 2 in. tire,	\$42.50;	complete with 9 ft. box, \$50.00
1 3/8 in. " " " " " " " " " " " "	48.50;	" " " " " " " " " " " " 10 ft. " 55.00
Double Box, Complete with Spring Seat,	\$11.00.	
Farmers' Handy Wagon with Steel Wheels	- - - - -	\$28.00
" " " " " " " " " " " " Wood "	- - - - -	30.00

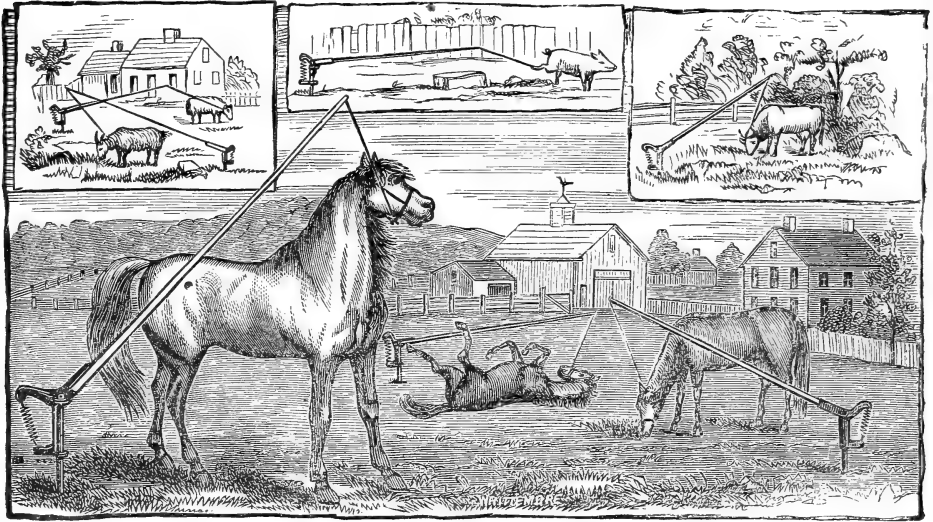

**WRIGHT'S ANIMAL TETHER—Price \$3.00**

Power Horse Clippers, \$7.50

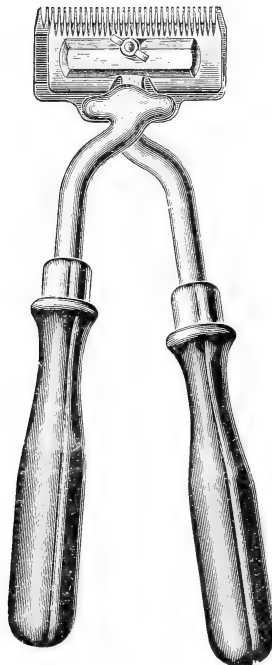

(HORSE CLIPPERS)

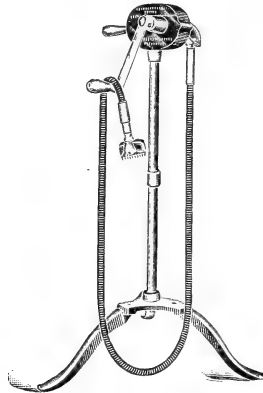

**TOILET CLIPPERS.**

From.....\$1.25 to 3.00

**HORSE CLIPPERS.**

From.....\$1.25 to \$2.50

**HARNESS.**

We carry Farm and Team Harness. Express and Light Harness, at attractive prices.

**CURRY COMBS.**

- 8-Bar, Common Steel.....10c
- 6-Bar, Best Steel.....20c
- 8-Bar, Best Steel.....25c
- Clock Spring.....25c
- Rubber.....75c

**HARNESS PUNCHES, (revolving) 85c**

**HARNESS SNAPS.**

- 7-8 in. 5c, 1 in. 6c, 1 1/4 in. 6c, 1 1/2 in. 7c, 1 3/4 in. 8c, 2 in. 10c.

**DANDY OR MANE BRUSHES**

- Rice Root..15c, 25c, 35c, 50c, 75c....
- Fibre.....35c

**WAGON COMBS (Horn).....25c**

**WAGON SHOES \$1.00 Each.**

**SPONGES, 35c, 50c, 75c, \$1.00.**

**CHAMOIS, fine large, \$1.00 each.**

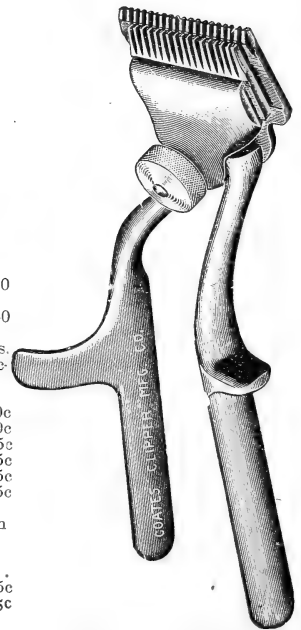

(TOILET CLIPPERS)

**BODY OR BRISTLE HORSE BRUSHES.**

25c, 50c, 75c, \$1.00, \$1.50, \$2.00, \$2.50, \$3.00 and \$4.00.

**FEED BAGS.**

Ventilated, 90c each. Common, 50c each

HOOF CLEANERS, - - - 25c

**HALTERS.**

Webb, 25c. Leather, 60c, 75c, \$1.00, \$1.25

**WHITE SAND.**

Per Quart, 5c. Per Bushel, - - \$1.00

FETLOCK SHEARS, - - - 1.00

FARRIER'S KNIVES, - - - 50c



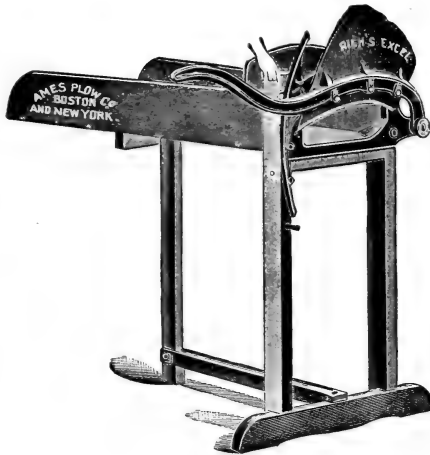

**LITTLE GIANT**

No. 0.....	\$1.65
No. 1.....	2.15
No. 2.....	2.50
No. 3.....	3.00
No. 3 (Ironed).....	3.50
No. 4.....	4.25
<b>LIGHT CARRIAGE JACKS.</b> —Price.....	.75
“ “ “ “ No. 1.....	1.25
“ “ “ “ No. 2.....	2.15
<b>ROPE TIES.</b> —Jute, 1 Snap.....	.10
“ “ “ 1 Snap and Ring.....	.15
“ “ “ 2 Snap and Ring.....	.20
“ “ Manila, 1 Snap and Ring.....	.25
“ “ “ 2 Snap and Ring.....	.30
“ “ Cotton, 1 Snap and Ring.....	.35

**RIVETING MACHINE**

Price each.....	.75
“ Rivets for Acme machine, per box.....	.10

<b>BROOM.</b> —Rattan Push, Common.....	65c
“ “ Extra.....	75c
“ Steel Push.....	\$1.00
“ Plain (Corn), extra heavy.....	70c
“ Rattan Mixed.....	75c
<b>BELLS.</b> —Team, Medium, 15c.....	and 25c
“ “ heavy.....	35c and 75c
Nice assortment Chime Bells for light Driving.	
<b>COPPER RIVETS.</b> — $\frac{1}{2}$ , $\frac{3}{8}$ and $\frac{1}{4}$ in.	per pkt. 15c
“ “ Slotted assortment.....	15c
<b>OAT SIEVES.</b> —17 in. diam., 55c; 19 in. 65c.	
<b>AXLE WASHERS.</b> —	Per Coil, 10c



<b>LANTERNS</b> —(Dietz) Lift wire No. 0, 50c; No. 1, 75c.	
<b>LANTERNS</b> —(Dietz) Blue Dash.....	75c
“ Cold Blast, \$1.00	
“ Tubular Driving Lamp.....	3.00
“ Barn Lamps, 1.50 and 2.25	
<b>LANTERN GLOBES</b> —No. 0, 10c; No. 1, 15c; red, 25c	
<b>LANTERN BURNERS</b> .....	10c
<b>HOLDERS</b> .....	25c
<b>HARNESS SOAP</b> —Frank Miller's pan.....	25c
<b>HARNESS SOAP</b> —Tub, \$1.00	
<b>HORSE POKES</b> .....	50c, 75c

**LEVER FEED CUTTER**

No. 1, Curved Knife.....	\$4.00
No. 2, “ “.....	5.00
No. 3, “ “.....	6.50

**CORNER MANGERS**

Heavy (flanged top).....	\$1.50
Medium.....	\$1.00 and \$1.25

**CORNER HAY RACK**

\$1.50

**WAGON JACKS**

<b>BOSTON.</b> —No. 1, (leather protection),	\$3.00
No. 2, “ “	3.50
No. 3, “ “	4.00

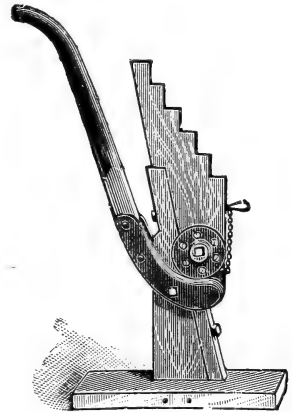

LITTLE GIANT JACK

<b>WHIPS.</b> —Nice assortment of Team and straight Whips and Lashes.	
<b>PAILS.</b> —J. I. C. (Oak Stable).....	75c
“ White pine stable.....	50c
“ Fibre, stable.....	.65c
<b>BUCKLEY WATERING DEVICE</b> .....	\$2.00
<b>BLANKETS.</b> —During the “BLANKET SEASON,” we carry a heavy stock of Street and Stable Blankets, and our prices are right.	
<b>BLANKET PINS</b> .....	5c
<b>AXLE GREASE.</b> —“4 Brothers,” per box, 10c; per pail, 25c and \$1: “Rapid,” per box, 10c	
<b>AXLE OIL.</b> —Castorine, Pints, 30c; Quarts, 50c	
<b>HARNESS OIL.</b> —“New Departure,” the best harness oil made. Pints, 35c; Quarts, 60c	
<b>NEAT'S FOOT OIL.</b> —Pints, 30c; Quarts, 50c.	
<b>HARNESS DRESSING.</b> —(Frank Miller's), Quarts 50c; Pints, 30c.	
<b>SPECIAL MACHINE OIL.</b> —Pints, 20c; Quarts, 30c.	
<b>MOWING MACHINE OIL.</b> —Bulk, per Quart, 12c and 15c; Bulk, per Gallon, 40c and 60c	
<b>SEPARATOR OIL.</b> —“Howard & Morrow's” Best, per Gallon, 65c.	
<b>GAS ENGINE OIL.</b> —Gallon can. 75c.	

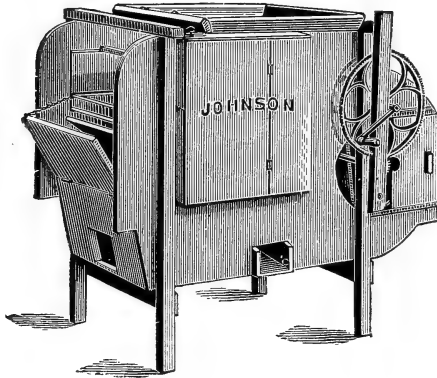

# THE JOHNSON FAN MILL

The Popular Fan of New  
England

PRICE, - - - - \$18.00

## Banner Root Cutter

A RAPID SLICER

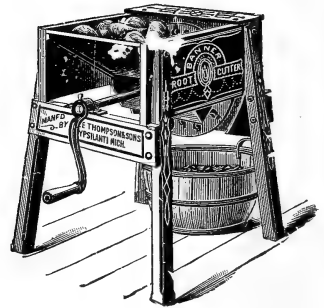

- No. 20, Hand Machine, - - - - \$10.00
- No. 16, Hand or Power Machine, - - - - 16.00

## Champion Root Cutter

Has one Set Fine Knives and one Set Coarse. Price \$8.00.

## National Cider Mills

Family Mill, one curb,	12½x12 in.,	List Price \$15.00	Net Price,	\$13.00
“ “ two “	16x15 in.	“ “ 20.00	“ “	17.00
“ “ “ “	17x16 in.	“ “ 28.00	“ “	24.00
Giant Geared, “ “		“ “ 37.50	“ “	32.00

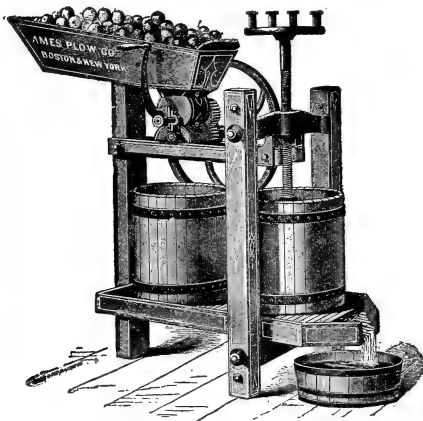

## LARD AND WINE PRESSES

- No. 1, 1 in. screw, - - - - \$ 5.75
- No. 2, 1½ in. screw, - - - - 7.00
- No. 3, 1¾ in. screw, - - - - 10.00
- No. 3½ iron beam, 1½ in. screw, 16.00
- No. 4, iron beam, 2 in. screw, 25.00
- No. 4, iron beam, 2 “ “ geared, 30.00
- No. 5, iron beam, geared, 2½ in. screw, 40.00

## GASOLINE ENGINES

### (The Fairbanks-Morse)

There are no better gasoline engines on the market than the "Fairbanks-Morse." They are well made, not complicated, parts are interchangeable, give full rated power, start easily and are thoroughly up-to-date.

The "Jack of all Trades" engine comes mounted on wood base as shown, ready for use in the following sizes; 2, 3, 4 and 6-horse power (actual).

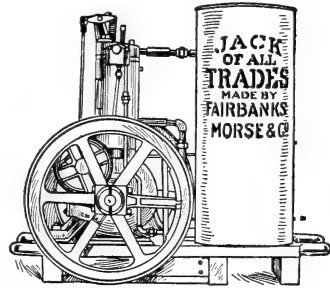

The Standard Vertical on iron base, as shown, comes with pulley, batteries, gasoline supply tank, cooling tank, exhaust pot and all short connections in the following sizes: 2, 3, 4, 6, 9 and 12 actual horse power

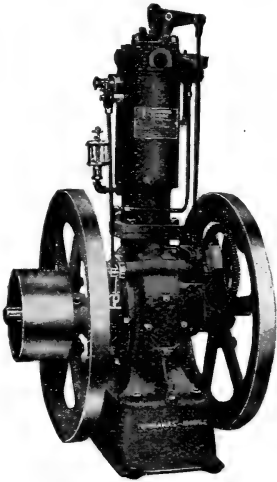

**FAIRBANKS-MORSE**  
Vertical Engine on Iron Base

The Vertical Portable is furnished in 2, 3, 4, 6, 9 and 12 actual horse power. (The 2-horse is furnished with hand truck, other sizes with shafts or tongue.)

The Special Electric Engine belted to dynamo, for lighting and heating, in sizes from 2-horse power up. If you need power we would like to talk with you.

Above all do not buy a cheap gasoline engine, you borrow trouble if you do.

## WOOD FRAME SAWING MACHINE

Made of Hard Wood, will accommodate saws from 20 in. to 30 in. in diameter. Balance wheel weighs 95 lbs. The frame can be fitted with pole extension if specially ordered, at extra cost. We recommend using 4 in. 4 ply rubber belting, 10 foot centers, 22 feet belt.

Tilting Table Complete with 22 in. Saw,	\$26.00
" " " " 24 " "	27.50
" " " " 26 " "	29.00

For Sliding Table add \$2.00. For Pole Saw add \$5.00.

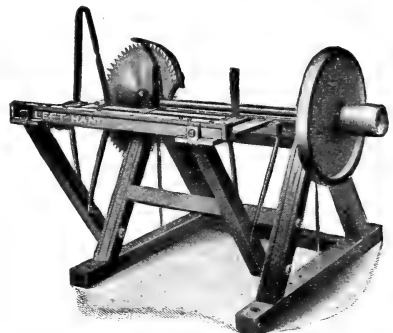

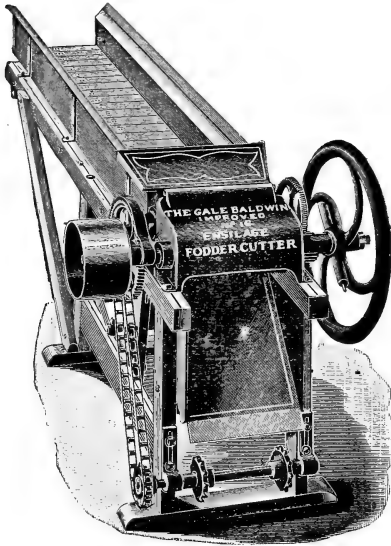

## GALE-BALDWIN ENSILAGE CUTTERS AND CARRIERS

We sell these either with or without Traveling Feed, with or without Carrier. These are powerful cutters, made very strong, have all modern improvements to make a perfect machine. A very important feature is that they are made near here so that there need be practically no delay in securing repairs when needed. Prices given on these are list. We give liberal discount.

Capacity Ensilage per hour	Power required without Carrier or Traveling Feed	List Price Plain Feed	List Price with Trav'g Feed
*No. 16, 2½ to 5 tons	1 to 2 H. P.	\$ 60	\$ 90
*No. 17, 5 to 10 tons	2 "	80	115
*No. 18, " " "	2 "	100	135
†No. 22, " " "	5 to 10 "	150	190

*STRAIGHT DELIVERY CARRIER.—12 ft. long or under,	- - - - -	\$24.00
ANGLE " " " " "	- - - - -	32.00
Over 12 ft. long, extra per ft.,	- - - - -	1.50
STRAIGHT DELIVERY CARRIER.—12 ft. long or under,	- - - - -	30.00
Over 12 ft. long, extra per ft.,	- - - - -	2.00
SAFETY TREADLE, extra,	- - - - -	5.00

# SILOS

The use of the silo on the dairy farm has long since passed the experimental stage and is now considered a fixed necessity. In the Weedsport we are offering you a first class silo, in sizes holding from 30 tons to 408 tons. They are made in White Hemlock, Canada spruce, Norway Pine, and White Pine with the Weedsport Improved Open Door Front. We want to figure with you on a Silo. Write or see us.

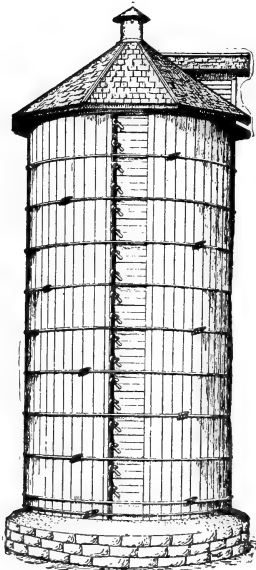

## OHIO ENSILAGE CUTTER

One of the strongest and most powerful cutters made, furnished with or without traveling feed table. The traveling Feed Table is a very valuable improvement in Ensilage Cutters, the fodder being carried steadily and regularly to the knives, saving much manual labor.

	No. of Knives	Length of Knives	Lengths Cut	List Prices Plain Table	List Prices Trv. T'bl
No. 13,	4	13 in.	Four lengths cut,	\$65.00	\$95.00
No. 16,	4	16 in.	" "	90.00	120.00
No. 18,	4	18 in.	" "	120.00	155.00
No. 19,	4	19 in.	" "	"	200.00
No. 20,	4	20 in.	" "	"	250.00

## The Climax Ensilage Cutter and Blower

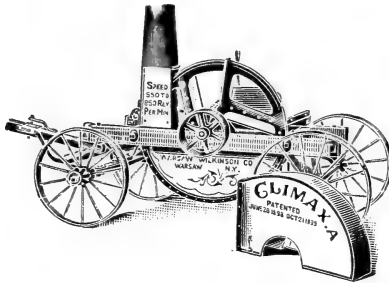

The great objection to a **Blower** has been the great amount of power required to successfully operate it. This has been overcome in the **Climax** combined machine. It is a wonder in this respect. Write or see us for descriptive circular and special prices.

## Wind Mills

Wind Mills are used extensively for developing power for Pumping, Cutting Ensilage and Fodder, Sawing Wood, Grinding Grain, etc., and are very economical, as practically the only cost is the first cost. If in need of such a power write us.

## FAIRBANKS' MORSE FEED MILLS

Especially adapted for farm use, Practical, Durable, Economical.

No. 1, with extra set grinding plates, \$24.00.

No. 2, with extra set grinding plates, \$35.00.

If without fly wheel deduct \$2.50.

Elevator and Bagger, extra, \$16.00.

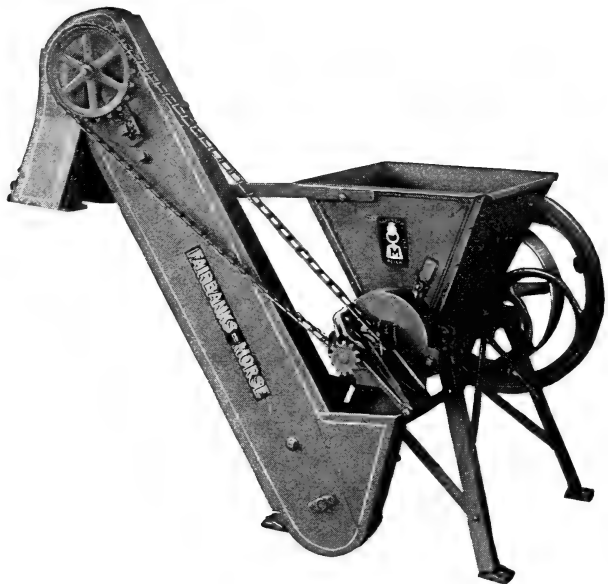

## Backus Water Motor

Exceptionally good for running Cream Separators and Dairy Machinery, where a water pressure can be had of 40 pounds or over. Write for our Special Water Motor Catalog.

**LION RIGHT HAND CORN SHELLER**

A very simple and popular Sheller.

There is only one size and that is with a separator. It is a

**RIGHT HAND SHELLER**

has a large, heavy balance wheel.

The working parts are held firmly together by solid shaft boxes or bearings.

PRICE, ONLY \$10.00.

**THE A SHELLER AND SEPARATOR**

This is a wood frame Sheller, capable of doing good and rapid work. Strong and well made.

PRICE, \$8.75.

**BURRELL RIGHT HAND  
IRON CORN SHELLER**

A popular low priced Sheller.

PRICE, \$6.50.

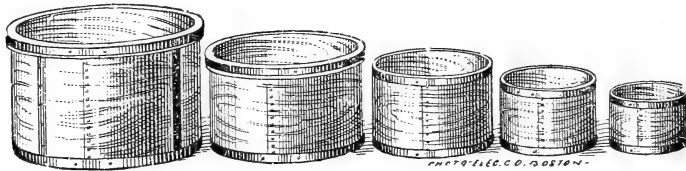
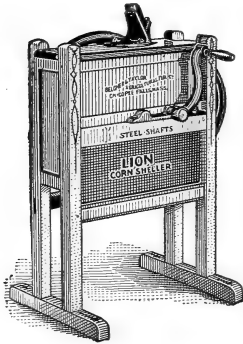

**OAK DRY MEASURES**

Best Iron Bound and Sealed, 1 qt. 20c, 2 qt. 30c, 4 qt. 40c, 8 qt. 60c, 16 qt. 75c, per set \$2.00.

Common Iron Bound, Not Sealed, 1 qt. 10c, 2 qt. 20c, 4 qt. 25c, 8 qt. 40c, 16 qt. 50c, per set \$1.25.

**STEEL DRY MEASURES**

2 qt. 30c, 4 qt. 40c, 8 qt. 60c, 16 qt. 75c.

**SEAMLESS GRAIN BAGS**

Per bale, 100 bags, - - - - - \$20.00, 22.00 and 25.00  
Each, - - - - - 24c

**BAG HOLDERS**

Metal Tunnel—Adjustable to desired height, very convenient  
Price, - - - - - \$3.50

**BARREL HEADER**

Iron Screw, heavy, - - - - - \$1.50

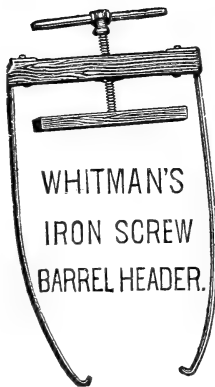

**SAP SPOUTS**

Ideal Metal, each 2 1-2 per 100. \$2.25.

**SAP PAILS**

Galvanized, heavy, 12 qt., per 100, \$18.50

“ “ 15 qt., per 100, \$21.50

SYRUP CANS.—One gal., square, screw top, each 12c; per 100, \$10.50.



Use it for all cement work about the farm.

**BOSTON PATTERN TRUCKS**

Sizes	Length Handles	Axle	Wheels Outside List	Net	Sizes	Length Handles	Axle	Wheels Outside List	Net
0	48 in.	3/4 in.	\$4.00	\$3.40	3	58 in.	1 in.	\$8.50	\$7.00
1	52 in.	3/4 in.	4.75	4.00	4	68 in.	1 1/2 in.	11.00	9.00
2	56 in.	7/8 in.	6.00	5.00	5	73 in.	1 1/4 in.	13.50	10.50

Barrel Trucks with Wood Bars, extra, 50c.

Barrel Trucks with Steel Bars, extra, for No. 1, \$1.00; No. 2, \$1.50; No. 3, \$2.00;

No. 4, \$2.50.

These Trucks have Bent Handles instead of sawed, and are in every way a first class truck.

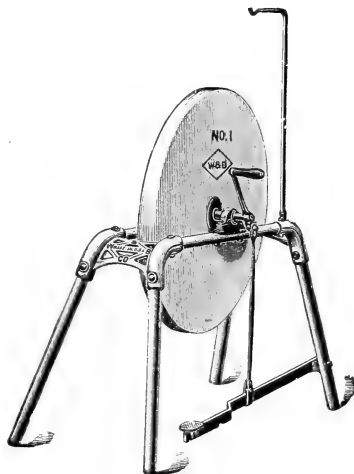

**MOUNTED GRINDSTONE**

	Weight.	Price.
"H. and M." all Steel Frame.....	130 lbs.	\$5.50
Extra.....	100 lbs.	4.50
No. 1.....	80 lbs.	4.00
Family Grindstones.....		1.00
Grindstones (plain), Nova Scotia, per lb.....		2 1/2c
Huron.....		.02
Grindstone Fixtures, per set heavy.....		1.25
(Medium).....		1.00
Extension Shafts for Grindstones.....		.25
Sickle Grinders.....		\$3.00 to \$5.00

**CARR'S IMPROVED TOOL AND KNIFE GRINDER.**

PRICE \$4.50.

**SCREEN DOORS**

Plain, 3 inch stile, wire black, price complete with trimmings.....	\$1.00
Light Finish, Fancy Pattern, 4 in. stile.....	\$1.25-\$1.50
Our Custom Made.....	\$2.50

**WINDOW SCREENS**

The "Leader," Hardwood Finish, Height 18 inch, Adjusts 20 in. to 33 in.,	25c
" " " " " " 24 " " " 20 " to 33 "	30c
" " " " " " 24 " " " 23 " to 37 "	35c
Sherwood Steel, 18 inch, 22 in. to 33 in.,	35c
" " " 24 " 22 in. to 33 in.,	40c
" " " 24 " 24 in. to 37 in.,	45c
<b>WIRE SCREEN CLOTH</b> —Per sq. ft.,	2 1/2c

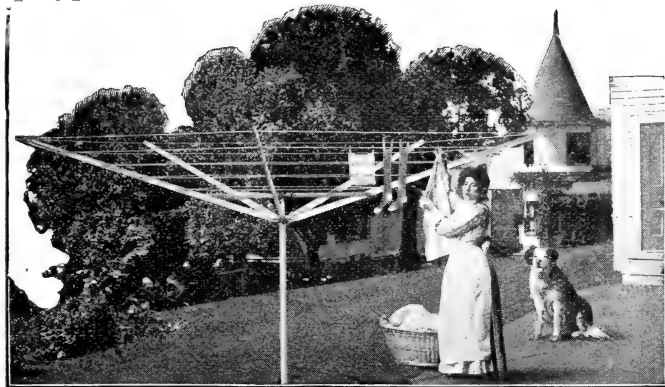

**HILL'S CLOTHES DRYER**

No. 1.....	\$6.70
" 2.....	7.30
" 3.....	8.50

**REVOLVING.**— Very convenient, easily folded, can be removed from standard, and placed under cover if desired. Price 110 ft., \$4.00; 150 ft., \$4.50.

**FLOWERING BULBS—In their Season**

**LILIES, TULIPS, NARCISSUS, FREESIAS, HYACINTHS, CROCUS, JONQUILS, ETC.**  
We import direct from Holland. They are fine, strong bulbs and will produce good bloom. We carry Cowee's Gladioli bulbs in their season. We procure for you at short notice any flowering bulbs wanted.

**REEDS.**—For Basket and Fancy Work. No. 1, No. 2, No. 3 and No. 4, per pkg., 20c.

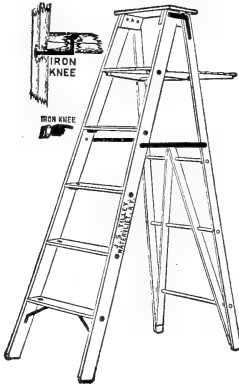

**ANCHOR STEP LADDERS,** 6 ft. .... \$2.00\*  
 (Very Strong) 8 ft. .... 2.50  
 10 ft. .... 3.00  
**GEM STEP LADDERS,** 4 ft. .... \$1.00  
 " " " 5 ft. .... 1.20  
 " " " 6 ft. .... 1.50  
 " " " 8 ft. .... 2.00

**COMMON LADDERS.**—Cambridge, best quality.  
 Stock length, 10, 12, 14, 16, 18, 20, 24 and  
 26 ft. Price per ft., 13c, 14c and 15c

**LADDER HOOKS,** Each. .... 75c

**BEST EXTENSION LADDERS.**—Sure lock, safest  
 extension made, price per ft., 25c, 30c, and 35c

**SECTION LADDERS.**—Per 6 ft. section. . \$1.50

**FOLDING CLOTHES FRAMES,** 40 ft. capacity  
 75c

**WIRE FLY KILLERS.**—Price. .... 10c

**CAN OPENERS.**—Price. .... 10c and 25c

**RIVAL ASH SIFTER.**—Dust cannot fly; fits on  
 barrel. Price. .... 75c

**COMMON ASH SIFTER.**—Large size, galvanized. .... 25c

**WINDOW BRUSHES.**—All Bristles (pitched in) .... 50c

" " " (wired in) .... 75c

" " " Large " .... \$1.00

Handles, extra. .... 15c to 25c

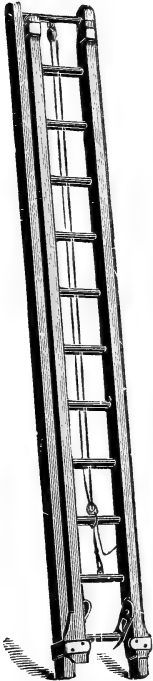

EXTENSION  
 LADDER

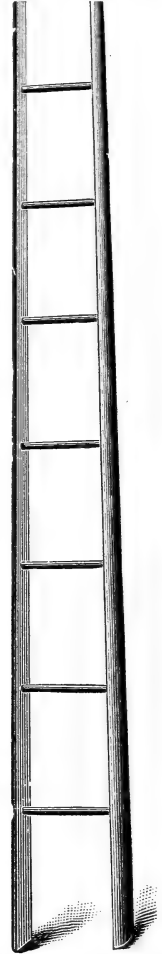
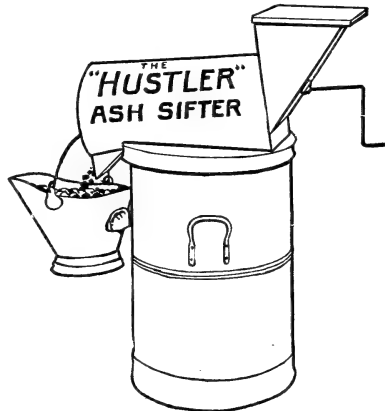

COMMON LADDER

**THE HUSTLER ASH SIFTER.**—Fits a barrel or can, Price without can \$4.50

**COAL HODS.**—Japanned. .... 25c

" " Galvanized. .... 25c to 45c

**GALVANIZED ASH CANS.**—With covers. . \$1.75, 2.00, 2.50, 3.00 and 3.50

**GALVANIZED GARBAGE PAILS.**—With cover. .... 75c, 85c, \$1.00 and 1.25

**SHOE BLACKING BRUSHES.**—With handles. .... 25c, 50c and 75c

**POLISHERS.** .... 50c. Fine. .... 75c

**METAL POLISH.**—Per can. .... 25c and 50c



**SCRUB BRUSHES.**—With handle, 20c: with-  
 out. .... 15c

**DAIRY QUEEN SCRUB.** .... 20c

" DUCK " .... 20c

**HOUSE BROOM.**—Fine No. 6, 45c: No. 7, 50c

**WHISK BROOMS.**—Prices 15c, 20c, 25c.

**WHITE WASH BRUSHES.** .... 25c to \$5.00

**PAIN AND VARNISH BRUSHES.**—We carry  
 the popular kinds and sizes in both round and  
 flat, paint and varnish.

**WHITE WASH LIME.**—Selected lumps, per  
 pound. .... 2c

**ALABASTINE.**—A splendid wall coating, much  
 better than Kalsomine, etc.—ready for use  
 by adding cold water—many shades—per  
 pkg. (5 lbs.) white, 50c., Colors, 55c.

**SOAP STONE FOOT WARMERS** 25c, 30c, and 35c



**Majestic Washing Machine**

Operated with crank and balance wheel, a splendid machine. Probably the best.

PRICE, \$7.00.

Wash Boards, 25c, 30c,  
35c, 50c

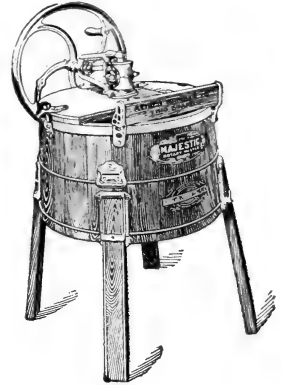

**Universal Wringer**  
AN OLD RELIABLE  
FAVORITE

No. 350, family size, warranted..... \$3.00  
No. 351, laundry size 3.75  
No. 352..... .500

**CHEMICAL WRINGER**—  
One of the best, No. 1050, \$5.00.

One of the best Ball Bearing, No. 1080, \$5.50.

**ROYAL WRINGER**—  
Ball Bearing, No. 590, \$4.50.

**DAISY WRINGER**—Iron Frame, No. 100, \$2.50

**FIBRE WASH TUBS**  
No hoops to fall off.

Price:  
No. 3.. \$1.00 | No. 1. \$1.25  
No. 2.. 1.15 | No. 0. 1.50

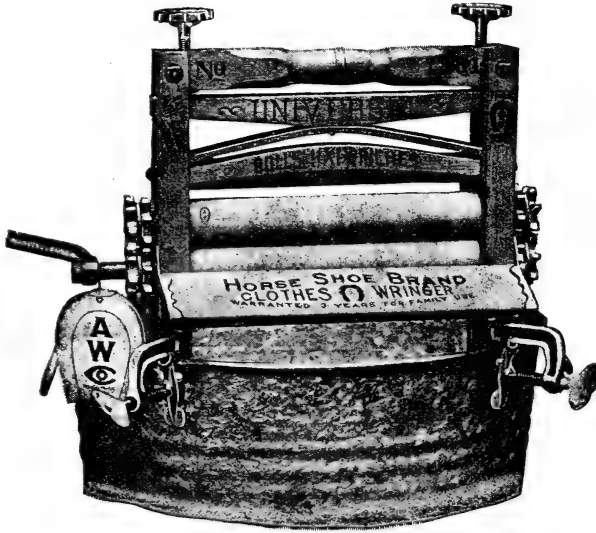

**GALVANIZED WASH TUBS.**—Large \$1.15; medium \$1.00; small 90c.

**OVAL CLOTHES BASKET**.....75c and \$1.00

**OBLONG CLOTHES BASKET.**—Hand made, 3 sizes, 75c and \$1.00, \$1.25.

**CLOTHES LINE.**—Cotton, 50 ft., 20c; 75 ft., 30c; 100 ft., 35c.

**CLOTHES LINES.**—Wire coil, 100 ft. .... 35c and 40c

**CLOTHES PINS.**—Per dozen..... 3c

**MOP STICKS.**—Each.....15c

**MOPS.**—Cotton..... 15c and 25c.

**LEVER MOP WRINGER.**—The best yet, family size, ..... \$1.50 and 1.75

**LEVER MOP WRINGER.**—Hotel size..... \$2.00

**UNIVERSAL BREAD MIXER.**—Regular size... 2.00  
Large size..... 2.50

**ECONOMY FRUIT JAR.**—The best yet, no rubber rings, self sealing, air tight, large at top, Keeps perfectly, meats, fish, vegetables or fruit.

Pints.....Per Doz. \$1.00  
Quarts..... " " 1.10  
Two Quarts..... " " 1.35  
Covers..... " " .20  
Lifters..... Each .10



# BOB SLEDS

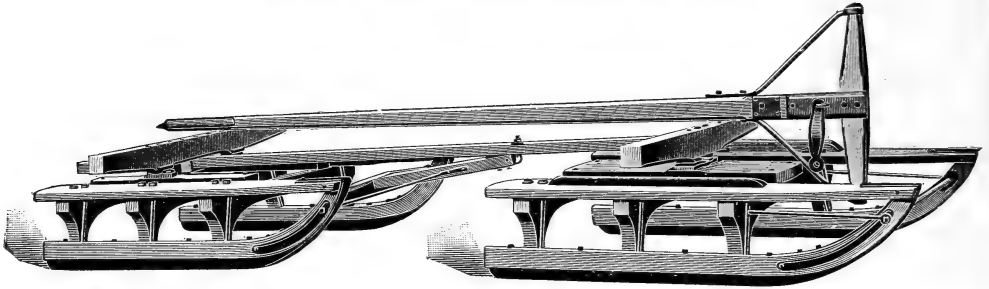

We carry these in medium, heavy and logging sleds, for farm, team, and logging work. They are high grade, long on the run, and the prices are very low. We have added to the lines, an Eastern made white oak logging bob, costing more money, but worth it. You should see them.

## Buckeye Double Acting Force and Lift Pumps A PERFECT WORKING, LONG-LIVED PUMP.

Valve is 5 1-2 feet below platform, consequently cannot freeze.  
No. 201, for wells up to 26 feet deep, takes 1 1-4 inch suction pipe. Price \$12.00.  
No. 216, for wells from 30 to 50 ft. deep, takes 1 1-2 inch suction pipe. Price \$15.00.

Prices on Pumps for deeper wells given on application.

## GASOLINE PUMPING OUTFITS

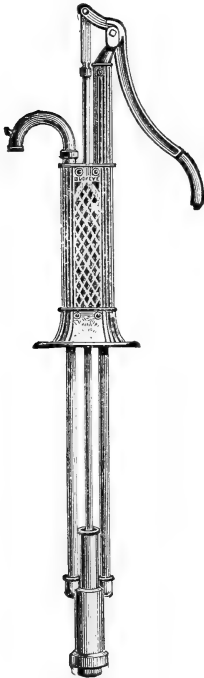

BUCKEYEPUMP

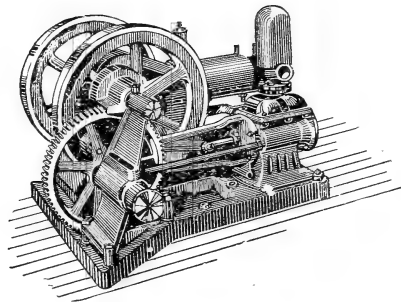

Where a large supply of water is required make an excellent equipment. If in need let us figure it for you.

## WIND MILLS AND WELL BORING

If you contemplate erecting a Wind Mill or boring a Well, we would be pleased to correspond with you and send an expert to make estimates.

## RUBBER BUCKET CHAIN PUMP A POPULAR LOW PRICED PUMP.

Curb with heavy castings.....	\$2.75
Tubing, best spruce, per foot.....	.10
Chain, galvanized, per lb.....	.12
Buckets, "Crosby".....	.15
Buckets, "Boston".....	.10
Rub Irons.....	.10

We will be pleased to figure the cost of Pump complete if you give us depth of well.

Pitcher Pumps, No. 1, \$2.50; No. 2, \$3.00; No. 3, \$3.25.

Well Points for driving, each \$1.50.

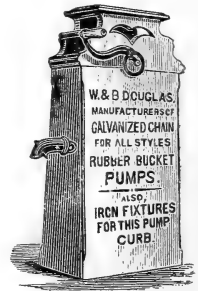

W. & B. DOUGLAS,  
MANUFACTURERS OF  
GALVANIZED CHAIN  
FOR ALL STYLES  
RUBBER BUCKET  
PUMPS  
— ALSO —  
IRON FIXTURES  
FOR THIS PUMP  
CURB.



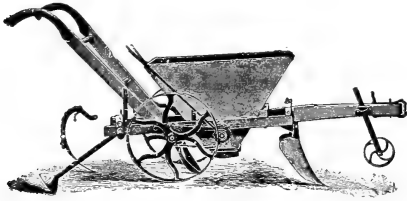

**STEVENS' FERTILIZER SOWER.**—For sowing fertilizer either broadcast or in drills by horse power. 5 ft. 10 in., \$45.00; 8 ft. 3 in., \$50.00; 10 ft., \$55.00.

**STEVENS' HAND FERTILIZER SOWER.**—For sowing fertilizer broadcast on lawns, etc. Price \$12.00.

## Perfection Drill and Fertilizer Sower

This machine will form a drill from 3 to 10 inches deep, and will drop into the drill any fertilizer at the rate of 100 lbs. to 3000 lbs. to the acre. Price, \$18.00



## Quinnipiac Fertilizers

### THE GREAT CROP PRODUCERS

**AVAILABLE PLANT FOOD.**—Is what the farmer is looking for when he buys commercial fertilizers.

That is just why the **QUINNIPIAC GOODS** stand so well.

They contain this plant food in the available form and in the right proportions to secure good results.

### PRINCIPAL BRANDS

**QUINNIPIAC MARKET GARDEN MANURE.**—Special attention is called to this brand as being as well formulated and as well balanced as any fertilizer on the market up to date. Per 100 lb. bag, \$2.20. Per ton, \$42.50.

**QUINNIPIAC PHOSPHATE.**—A standard fertilizer for general use on all crops. Its record for uniformity of grade and mechanical condition is remarkable. It is always reliable. Per 50 lb. bag, \$1.00. Per 100 lb. bag, \$1.95. Per ton, \$37.00.

**QUINNIPIAC POTATO MANURE.**—Formulated and balanced the same as Market Garden Manure, but not quite so high grade. As a potato grower it has won and maintained a high standing and an enviable reputation. Per 100 lb. bag, \$1.95. Per ton, \$37.00.

**QUINNIPIAC GRASS FERTILIZER.**—For spring use a top dressing for lawns, meadows and pastures. It acts quickly and produces a luxuriant growth of grass. It pays to use it. Per 50 lb. bag, \$1.25. Per 100 lb. bag, \$2.35. Per ton, \$44.00.

**QUINNIPIAC PURE BONE MEAL.**—Made from absolutely pure bones, finely ground and in the best mechanical condition. Per 100 lb. bag, \$2.25. Per ton, \$42.00.

**QUINNIPIAC CLIMAX PHOSPHATE.**—A well balanced fertilizer, but lower grade than Quinnipiac Phosphate. Per 100 lb. bag, \$1.70. Per ton, \$32.00.

We can supply Quinnipiac Fertilizers in grades that are lower in price—that will compare favorably in quality with other makes costing the same money.



# The Mapes Manures

For All Soils  
and for all Crops

## BASIS:

Pure Bone  
Made Soluble  
No Rock Used

## PRINCIPAL BRANDS

- MAPES POTATO MANURE.**—For potatoes, Early Vegetables, Fruit, Sweet Corn, etc.  
Per 100 lb. bag, \$2.25. Per ton, \$43.00
- MAPES CORN MANURE.**—Also for Sweet Corn, Fodder Corn, Hungarian Grass, Millet and Seeding Down to Grass.  
Per 100 lb. bag, \$1.95. Per ton, \$37.00
- MAPES ECONOMICAL POTATO MANURE.**—A little less in price than the Potato Manure, but adapted to early vegetables and other crops where a large percentage of Soluble Potash is required.  
Per 100 lb. bag, \$2.10. Per ton, \$40.00
- MAPES VEGETABLE OR COMPLETE MANURE.**—For light soils, for Truck, Early Vegetables, Onions, Celery, Tomatoes, etc.  
Per 100 lb. bag, \$2.35. Per ton, \$46.00
- MAPES COMPLETE MANURE.**—For Grass Top Dressing and Lawns. A high Grade Special, a substitute for stable and free from weed Seeds.  
Per 100 lb. bag, \$2.35. Per ton, \$46.00
- MAPES CEREAL BRAND.**—An exceptionally good fertilizer, specially adapted for all farm crops in connection with farm manure.  
Per 100 lb. bag, \$1.70. Per ton, \$33.00

We can supply you any other brand of Mapes Fertilizers upon application, and will be pleased to quote you prices on same, as well as analysis on all Mapes Brands which our space compels us to omit here.

We can recommend the above fertilizers as being derived from the best sources of plant food, and we are confident their use will prove this, and the results will be satisfactory and pleasing to you.

WE HAVE TAKEN THE AGENCY FOR THE ROGERS MFG. CO.'S FERTILIZERS, AND WILL BE PLEASED TO GIVE YOU BRANDS AND PRICES ON APPLICATION.

# Agricultural Chemicals

—AND—

## Fertilizing Materials

PRICES ON APPLICATION WHERE NOT GIVEN.

**MURIATE OF POTASH.**—80 to 85 per cent. muriate of potash, 5 lb. pkg., 35c; 10 lbs. 60c; 50 lbs., \$2.50; 100 lbs., \$4.00.

**DOUBLE SULPHATE OF POTASH AND MAGNESIA.**—48 to 52 per cent. sulphate of potash 35 to 40 per cent., sulphate of magnesia and not over 2½ per cent. chlorine; 26 to 28 per cent. actual potash.

**HIGH GRADE SULPHATE OF POTASH.**—90 to 95 per cent. sulphate of potash; 50 to 52 per cent. actual potash.

**KAINIT.**—23 to 25 per cent. sulphate and muriate of potash; 12 to 13 per cent. actual potash.

**SULPHATE OF MAGNESIA (Keiserite)**—50 to 55 per cent. sulphate magenisia.

**NITRATE OF SODA.**—94 to 96 per cent. purity, 5 lb. pkg., 30c; 10 lbs. 50c; 25 lb. \$1.25; 50 lb., \$2.00; 100 lbs., \$3.75.

**SULPHATE OF AMMONIA.**—24 3-4 to 25 1-4 per cent. ammonia.

**DRIED BLOOD.**—12 to 14 per cent. ammonia.

“ “ —10 to 12 “ “

“ “ — 8 to 10 “ “

**DISSOLVED BONE BLACK.**—15 to 18 per cent. soluble and available phosphoric acid.

“ “ “ —13 to 15 “ “ “ “ “ “

**PLAIN SUPERPHOSPHATE.**—12 to 15 “ “ “ “ “ “

**FINE GROUND TANKAGE.**—6 to 7 per cent. ammonia; 30 to 35 per cent. bone phosphate.

“ “ “ —7 to 8 “ “ 25 to 30 “ “ “

“ “ “ —8 to 9 “ “ 20 to 25 “ “ “

“ “ “ —9 to 10 “ “ 15 to 20 “ “ “

**ASHES.**—Canada.—Unleached. Per 100 lb. pkg., \$1.00. Per ton, \$18.00.

**DRY GROUND FISH.**

**BONE**—“Quinnipiac Bone Meal”—per cwt., \$2.25. “Raw Bone Flour”—per cwt., \$2.50

“Raw Bone Meal”—per cwt., \$2.50. Cracked Bone “Oatmeal”—per cwt., \$2.75.

**PURE NOVA SCOTIA GROUND PLASTER.**—Per 100 lb. bag, 60c.

**PULVERIZED SHEEP MANURE.**—Per 25 lb. bag, 80c; 50 lb. bag, \$1.25; 100 lb. bag, \$2.00. Per ton, \$35.00.

**CLAY'S FERTILIZER.**—Imported.

**GUANO.**—Peruvian.

**SCOTCH SOOT.**—Imported, 100 lb. bag, \$4.25.

**FARMOGERM.**—A preparation of nitrogen—gathering bacteria in sealed bottles ready for use by adding water as directed.

Price per acre \$2.00 in ordering state for what crops.

White Clover,	Cow Peas,	Soy Beans,
Red “	Canada “	Garden “
Crimson “	Garden “	Vetches
Alsike “	Sweet “	
Alfalfa “	Garden size—per bottle, 50c.	

# INDEX

SEEDS.	Page		Page.		Page
ARTICHOKE,	2-25	Boilers, Farmers,	76	Fertilizers and Sowers, 92-93-94	92
Asparagus,	2	Bordeaux, Mixture,	50	Files,	44
BARLEY,	26	Bowls, Wood,	69	Flails,	59
Beans,	2-3-4	Boxes, Butter,	66	Floats, Masons,	52
Beets,	4-5	Boxes, Lunch,	78	Floral Sets,	40
Bird Seed,	25	Brackets, Flower Pot,	78	Flower Bed Guard,	43
Broccoli,	5	Bread Mixer,	89	Flower Stems,	40
Brussels Sprouts,	5	Brooders and Stoves,	72	Flower Supports,	40
Buckwheat,	26	Brooms, House and Whisk,	88	Flue Lining,	45
Bulbs, Flowering,	87	"    Barn,	81	Fly Killers,	49-88
CABBAGE,	6	Brushes, Counter,	78	Food, Horse and Cattle,	70-71
Carrots,	6-7	"    Horse,	80	"    Poultry,	71-73-74
Cauliflower,	5	"    Lather,	78	Forks, Barley,	42
Celery and Celeriac,	7	"    Paint, White Wash	88	"    Harpoon,	60
Chervil and Chicory,	7	"    Shoe,	88	"    Hay,	42
Chives,	25	"    Window and Scrub	88	"    Horse, Hay,	60
Corn Salad,	7	Buckets, Well,	78-90	"    Manure,	42
Corn,	8-9	Bug Death,	50	"    Spading,	42
Cress or Pepper Grass,	9	Bulb, Putty,	41	"    Weeding,	40
Cucumbers,	9	Butter Boxes, Shipping,	66	"    Wood, Stable,	67
DANDELION,	9	"    Color,	66	Fountains, Poultry,	75
EGG PLANT,	10	"    Moulds,	67	Fumigators,	49-51-75
Endive,	10	"    Spades and Ladles,	67	GATHERERS, Fruit,	40
FLAX,	26	"    Workers,	65	Gauge, Cream,	67
Flower Seeds,	21-22-23-24	CALF MEAL,	70	Gimlets,	42
GARLIC,	25	Calf Cordial,	70	Glass Cutters,	40
Gourds,	10	Canes, Bamboo	40	Glue,	42
Grass Seed,	25-26	Cant Hooks,	71	Grafting Wax,	59
HEMP,	25	Cans, Ash and Garbage,	88	Grass Catcher,	48
Herbs,	20	"    Milk,	63-68	"    Hooks,	41
Horse Radish,	25	"    Syrup,	86	Gravel, Bird,	78
Hungarian Grass,	26	Can Openers,	88	Grease, Axle,	81
KALE or BORECOLE,	10	Cards, Horse and Cattle,	67	Grindstones,	87
Kohl Rabi,	10	Carriers, Butter,	66	Grindstone Fixtures,	87
LAWN GRASS,	26	"    Ensilage,	84-85	Grinders, Knife and Tool,	87
Lettuce,	10-11	"    Hay and Parts,	60	Grit, Poultry,	74
Leek,	11	"    Timber,	71	Guns, Paris Green,	51
MILLET,	25-26	Carts, Farm and Contractors,	54	"    Insect Powder,	49-51
Melon, Musk and Water,	11	"    Hand,	41-48	HAIR, Plastering,	52
Mustard,	11	Cement,	52	Halters,	80
Mushroom Spawn,	12	Chains,	71-90	Hammer, Nail, Rivet, Tack,	61
NASTURTIUM,	23	Chamois,	80	"    Hand Sledge,	71
OATS,	26	Charcoal,	74	"    Stone,	71
Okra or Gumbo,	12	Chisels, Cold,	61	Handles,	52-59-88
Onion, Onion Sets,	12-13	"    Ice,	91	Harness,	53-80
PARSLEY,	13	"    Sidewalk,	75	Harrow,	31-32
Parsnip,	13	Chloride Lime,	51	Hatchets,	42
Peas,	13-14-15	Choppers, Meat,	78	Hay Caps,	61
Peppers,	16	Churns,	64-65	Hay Racks,	81
Pumpkins,	16	Chute, Window Coal,	53	Headers, Barrel,	86
Potatoes,	15-16	Clippers, Horse and Toilet,	80	Heater, Fountain,	75
RADISH,	17	Clothes Dryers and Frames,	87-88	Hocks, Masons,	52
Rape,	25	Clover,	74	Hods, Masons,	52
Rhubarb,	17	Combs, Curry and Mane,	80	"    Coal,	88
Rye,	26	Coolers, Milk,	66	Hoe, Horse,	35-37-38-39
SALSIFY or Vegetable	17	Cork Screws,	78	"    Scuffle,	40
Oyster,	17	Corn Husker,	34	"    Steel,	42
Special Grass Mixture,	25	Corn Binder,	34-55	Hog Scrapers, Catchers and	78
Spinach,	18	Cradles, Grain,	59	"    Rings,	78
Squash,	18	Creamers, Cooley,	63	Holder, Bag,	86
Sunflower,	23	Cultivators, Hand,	36-37	Hoof Cleaners,	80
Sweet Peas,	25	"    Horse,	35-37-38-39	"    Packing,	78
TARRAGON,	18	Cure, Roup, Cholera, Gape,	73	Hook, Bird Cage,	71
Tobacco,	19	Cutters, Bone,	73	"    Cant or Log,	71
Tomato,	19-20	"    Clover,	73	"    Brush,	59
Turnip,	26	"    Ensilage,	84-85	"    Grass,	41
WHEAT,	26	"    Lever, Hay,	81	"    Potato,	42
TOOLS, FERTILIZERS,		"    Slaw,	78	"    Ice,	91
INSECTIDES, ETC.		"    Vegetable,	78-82	"    Hammock,	98
AGRICULTURAL Chemicals,		Cuttle Bone,	78	"    Bale or Box,	78
Alabastine,	88	Cyphers Chick Food,	74	Hose,	46
Animal Meal,	74	DAIRY GOODS,	62-71	"    Band and Couplings,	46
Aprons, Rubber,	67	Death to Lice,	75	"    Nozzle Holders,	46
Ashes,	94	Dehorner,	62	"    Menders and Pliers,	46
Axes,	59	Diggers, Post Hole,	77	"    Reel,	46
BABCOCK Tester,	63	Digger, Potato,	39	"    Washers,	46
Bags, Seamless,	86	Dilators, Teat,	67	Hovers,	72
Bags, Feed,	80	Dressing, Harness,	81	ICE CREEPERS,	91
Bands, Leg,	73	Drill, Seed,	33-34-36-39	"    Tools,	59-69-91
Bars, Crow,	71	"    Hand Stone,	71	Incubators,	72
Barrows, Canal,	53	"    Dumping Wagon,	71	Insecticides,	49-50-51-75
Barrows, Garden,	27	Dusters, Counter,	78	JACKS, Wagon,	81
Baskets,	39-89	EDGERS, Turf,	42-48	Jars, Fruit,	89
Baskets, Bottle Carrying,	69	Egg Carriers,	73	KNIVES, Asparagus,	40
B. B. B.,	74	Eggs, Nest,	73	"    Budding and Prun-	41
Bells, Cow,	67	Engines,	83	"    Butcher and Kit-	41
Bells, Sleigh,	81	"    Inside back cover,	49	"    Carving and Table,	78
Binder, Grain and Corn,	55-58	Evaporating Lamp	71	KNIVES, Chopping,	78
Bits and Braces,	42	Eveners,	71	"    Corn,	41
Blankets and Pins, Horse,	81	FARMOGEM,	94	"    Edging,	42
Bone, Cracked,	74-92-94	Faucets,	61	"    Farrier's,	80
Bone Meal,	74-92-94	Feeders, Calf,	71	"    Pocket,	78
Boots, Lawn,	48	Fencing,	76-77		

	Page
KNIVES Hay,	59
" Putty,	42
LABELS, Plant and Garden,	40
" Cattle and Sheep,	62
Ladders,	88
Ladder Hooks,	88
" Steps,	88
Lantern and Burners,	81
" Globe and Holders,	81
Lawn Boots,	48
" Mowers,	47-48
" Repairing,	26
Leaders, Cattle and Bull,	67
Lenox Remedies,	70
Levels,	42
Lice Killer,	75
Lime,	52-88
Lines, Garden,	40
" Clothes,	89
Loaders, Hay,	58
Locks, Pad,	52-68
MANE COMBS	80
Manger, Corner,	81
Manure Spreader,	31
Marker and Furrower,	35
Marline, Tarred,	41
Mastica,	41
Mattocks,	59
Mats, Hot Bed,	41
Maul, Cast Iron,	77
" Woodchoppers,	71
Measures, Dry,	86
" Milk,	67
Measuring Rods,	53
Mills, Bone,	73
" Coffee,	78
" Cider,	82
" Fanning,	82
" Grist,	85
" Wind,	85-90
Milk Bottles and Caps,	69
" Tubes,	67
Mixer, Bread,	89
Mortar Red,	52
Motors, Water,	85
Mops, Rubber,	67
" Cotton and Sticks,	89
Moss,	41
Mowers, Horse Lawn, Motor,	47
Mowers, Hand,	47-48
Mowing Machines,	54-55-56
" Mowing Machine, Sections and Repairs,	61
NECK YOKES,	71
Nests, Wire,	73-74
Netting, Poultry,	76
Nikoteen and Nicoticide,	50
Nozzle Hose,	45-46
Nutritone,	70
OIL, Axle, Machine and Gas	81
" Engine,	81
" Harness and Separator,	81
" Cans,	61
Ox Bow Pins,	67
Ox Muzzles and Buttons,	67-88
PAILS, Dairy and Cream,	63-67
" Dinner,	78
" Fibre and Stable,	81
" Galvanized,	67-68
" Sap,	86
" Wood,	81-86
Paint, Inside front cover and	70
Pans, Milk,	68
Paper, Butter,	69
" Wax and Tissue,	39
Parers, Apple,	78
Paris Green,	50
Pencils,	42
Pickers Fruit,	40
Picks, Railroad and Contrac-	52
" tors,	89
Pins, Clothes,	89
Plant Food,	50-51
Planter, Corn,	34-38
" Potato,	39
Plaster, Masons',	52
" Land,	94
" Wall,	52
Pliers,	46-77
Plows,	28-29-30-35
Polish, Metal,	88
Points, Stone Cutter,	71
Points, Well,	90

	Page
Polo Sticks,	91
Pokes, Horse,	81
Poppers, Corn,	78
Potash,	51-94
Posts, Iron,	77
Post Hole Spoons,	77
Pots, Flower,	44-45
Pots, Watering,	43
Poultry Feeding Box,	73
" Supplies,	70-77
Power, Sheep or Dog,	63
Pruners,	41-59
Press, Wine or Lard,	82
Pulleys,	60-78-91
Pumps,	46-49-90
Punches, Bull,	67
" Harness,	80
" Label,	62
" Mowing Machine,	61
" Poultry,	73
RAKES, Hay, Drag and Lawn,	48-58
" Steel,	42
" Horse Hay,	56-57-58
Raphia,	41
Razors,	78
" Straps and Hones,	78
Reeds,	87
Reel, Garden,	40
" Hose,	46
" Clothes,	87
Repairs,	26-31-61
Revolvers,	78
Ridgers,	35-38-39
Rings, Brass,	78
" Bull,	67
" Key,	42
Riveting Machine,	81
Rivets, Copper,	81
Rollers, Garden and Lawn,	26-27
" Field,	27-33
Roofing,	70
Rope,	60
Ruberine,	70
Rules,	42
SALT,	66
Sand,	80
Sanitary Feeding Box,	73
Saw Frames,	59
Sawing Machines,	83
Saw Bucks,	59
" Carpenters',	59
" Cross Cut,	59
" Ice and Meat,	59
" Pruning,	59
" Sets,	59
Scales,	69
Scissors,	41-78
Scrapers, Hog,	78
" Steel Road,	53
" Tree,	41
" Wheel,	53
Screen Sand,	41-52
Screen Cloth,	87
Screen Door and Window,	88
Scythes and Snaths,	61
Sections,	61
Separators, Cream,	62
Separator Oil,	81
Shaving Mugs,	78
Shears, Border, Hedge and	59
" Branch,	59
" Fetlock,	80
" Pruning, Sheep,	41
" Grass,	41-59
" Flowers and Grape,	41
Sheep Dip,	50
Shellers, Corn,	86
Shells, Oyster and Sea,	74
Shovels, Spades and Scoops,	52
Shovels, Snow,	75
Sieves, Oat,	81
" Flour,	78
" Coal,	88
Silkaine,	41
Silos,	84
Silver Pine Healing Oil,	71
Skates,	91
Skees,	91
Sledges,	71
Sleds,	90-91
Slicers, Potato,	78
Slug Shot,	50
Snaps, Harness,	80

	Page
Soap, Harness,	81
Soot,	94
Sowers, Fertilizer, 33-34-35-92	33-34-35-36-39
" Seed,	33-34-35-36-39
Sponges,	80
Spouts, Sap,	86
Spratts' Poultry Meal,	74
Sprayers,	43-45-46-49-51
Sprinklers, Lawn,	46
" Plant,	41-43-46
Squares,	59
Staffs, Bull,	67
Stakes, Plant,	40
Stanchions,	62
Staples, Wire and Netting,	76-77
Steelyards,	69
Stone Boats,	71
" Boat Front,	71
Stones, Axe,	59
" Scythe,	58
" Soap,	88
Strainers, Milk,	67-69
Stretchers, Wire,	77
Sulpho Napthol,	51
Sulphur,	50
Sultar,	51
Support, Carnation and To-	40
" mato,	40
Syringes, Plant,	46
TACKLE, Blocks,	60-78
Tacks and Pulls,	78
Tampers,	77
Tape Lines,	52
Tar,	71
Tar Paper,	70
Tedders, Hay,	56-57
Testers, Milk,	63
Testers, Egg,	73
Tethers, Animal,	80
Thermometers,	40-69-75
Ties, Rope,	81
" Bale,	60
" Corn,	34
" Cow,	62
Tile,	44
Tobacco Stems,	50
Tobacco Dust and Extracts,	50-51
Toboggans,	91
Tongs, Ice,	91
Traps, Rat, Mouse Game,	78
Traps, Mole,	41
Trellis, Tomato,	40
Trowels, Garden,	52
Trowels, Masons,	52
Trucks,	48-57
Tubing, Pump,	90
Tubs, Flower,	40
Tubs, Wash,	39
Twines,	41
VANES,	67
Varnish, Inside front cover	41
Vases, Cut Flower,	41-45
" Cemetery,	41
Vises,	61
WAGONS,	79-91
" Bottom Dump,	54
Wagon Shoes,	80
Water Barrel Truck,	48
Watering Device, Buckley's,	81
Washers, Axle,	81
Washing Boards,	89
" Machines,	89
" Powder, Wyandotte,	65
Watering Pots,	43
Weaners, Calf,	67
Wedges, Wood Splitting,	71
Wedges, Axe,	59
Wedges, and Shims,	71
Weeders, Horse,	39
" Hand,	40-46
Whale Oil Soap,	50
Whiffletrees,	71
Whips,	81
Window Coal Chute,	53
Wire, Fencing,	76-77
Wire Greenhouse,	41
Wool Twine,	41
Wrenches, Monkey,	61
" Scythe,	58
Wringers, Clothes and Mop,	89



---

# The J. I. Case Engines

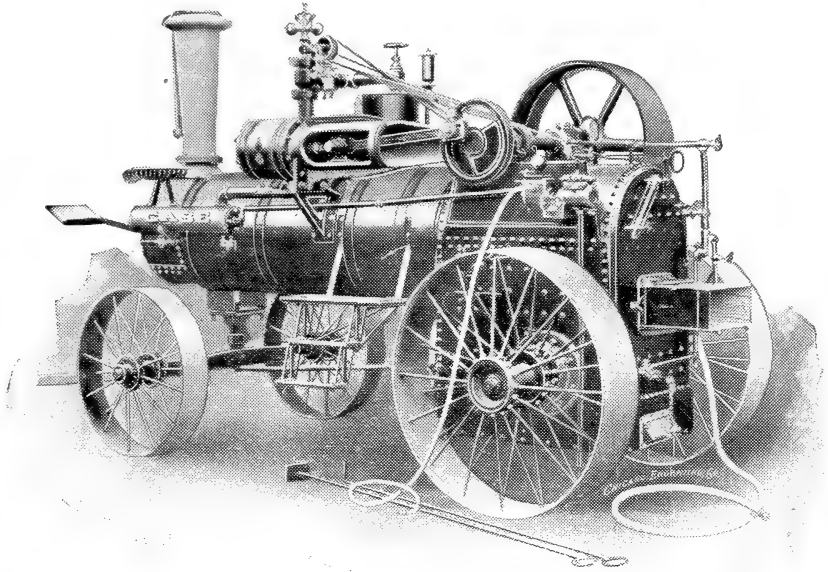

THESE ENGINES ARE MADE IN PORTABLE, TRACTION AND SKID ENGINES, IN SIZES FROM 6 TO 32 HORSE POWER. THEY ARE FIRST-CLASS GOODS AND WILL DEVELOP THE FULL HORSE POWER RATED.—WE WANT TO SEE YOU BEFORE YOU BUY. WE ARE HEAVY DEALERS IN LIME, CEMENT, WALL PLASTER, TILE, FLUE LINING, SCRAPERS, BARROWS, PICKS, SHOVELS AND ALL CONTRACTORS TOOLS.

---

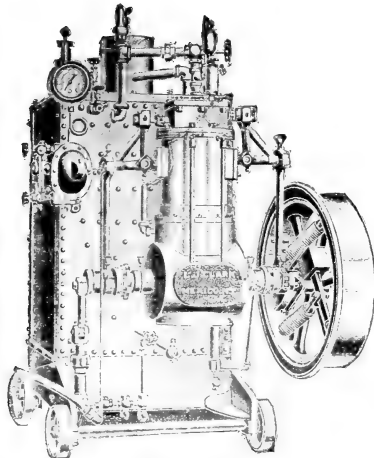

## The Safe Engine and Boiler

AN ECONOMICAL, SAFE, POWERFUL ENGINE, ADAPTED TO ALL USES ON THE FARM WHERE POWER, STEAM, OR BOTH ARE REQUIRED.

A VERY SATISFACTORY ENGINE. MADE IN THE FOLLOWING SIZES. 3, 4, 5, 6, 8, 10 HORSE POWER.—GET OUR PRICES.

---

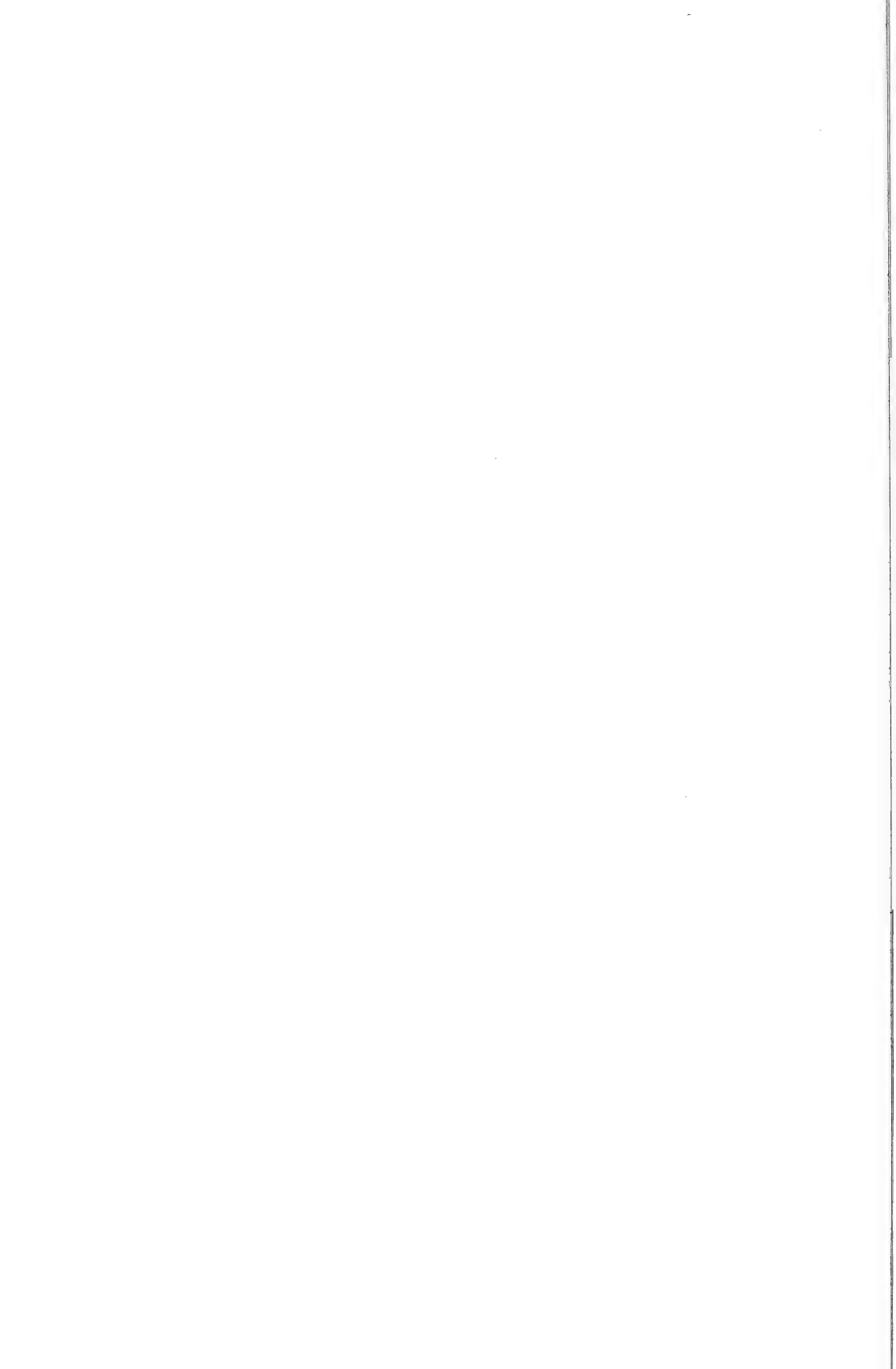

**Howard & Morrow,  
59 North Street,  
Pittsfield,  
Mass.**

**Seeds, Tools,  
Fertilizers,  
Lime and Cement,  
Tile, Flue Lining.**





1910

Seeds

Tools

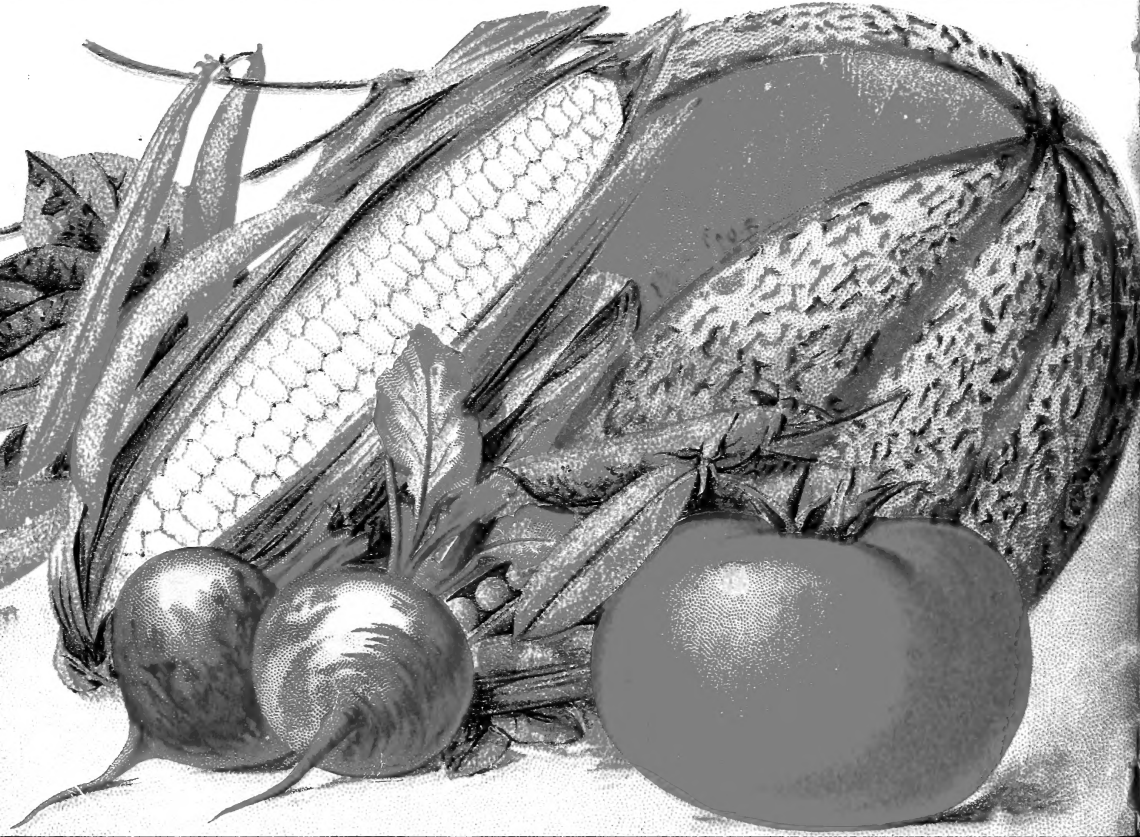

*Howard & Morrow*

*59 North Street, Pittsfield, Mass.*